

# ROTONDA 640

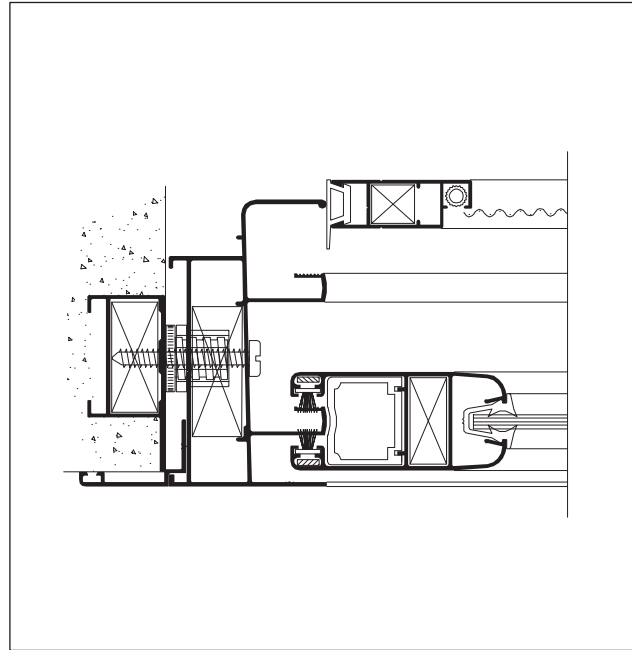

<b>Indice</b>	<b>Página</b>
Notas Generales	03
Especificaciones Técnicas	04
Esquema de cortes típicos	06
Indice de Perfiles	08
Perfiles	12
Accesorios	27
Guarniciones	31
Secciones	32
Límites de utilización estática	50
Medidas de corte	53
Mecanizados	63
Detalles	73

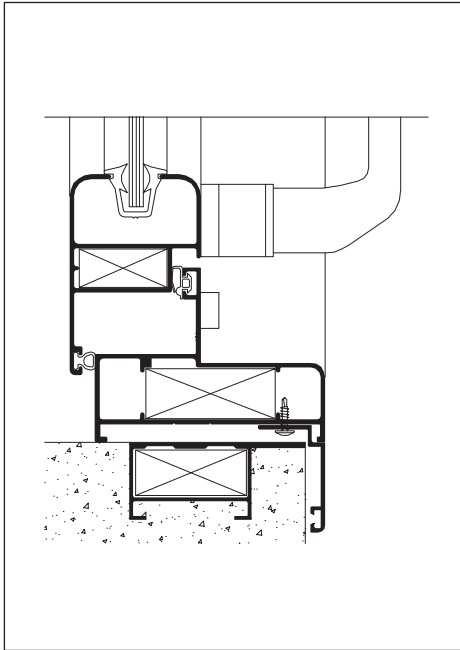

# ROTONDA 640

<b>Peso de los perfiles:</b>	el peso indicado es teórico y podrá variar en función de las tolerancias de espesor y dimensionales de extrusión.
<b>Dimensiones de los perfiles:</b>	las dimensiones indicadas son teóricas y podrán variar en función de las tolerancias dimensionales de extrusión.
<b>Medidas de cortes:</b>	las medidas de corte indicadas en el presente catálogo son exactas; en algún caso deberán ser redondeadas en función a la precisión de las máquinas disponibles por el carpintero.
<b>Prototipo:</b>	se aconseja en los primeros trabajos o antes de construir una cantidad importante de aberturas, la elaboración de un prototipo en dimensión real.
<b>Longitud de las barras:</b>	la longitud comercial de los perfiles de esta serie es de 6020 mm. , <b>excepto cuando se indica lo contrario.</b>
<b>Puesta en obra:</b>	la representación de la puesta en obra es solo indicativa, una sugerencia de cómo puede resolverse en forma simple y efectiva, esta particular problemática de la carpintería. <b>RECOMENDAMOS ENFATICAMENTE EL USO DE PREMARCO.</b>

Todas las secciones, conjuntos, ensambles, mecanizados y formas de montajes que se muestran en los catálogos de **HYDRO ALUMINIUM ARGENTINA**, corresponden al estado actual de la técnica, han sido definidos con cuidado y competencia, y significan un servicio para el fabricante, aportando, sin compromisos, propuestas y sugerencias.

El fabricante debe verificar, en cada caso, si las propuestas corresponden o son aplicables a los casos que se le presenten, ya que las múltiples posibilidades que se encuentran en la práctica no pueden estar todas representadas en un catálogo.

Los diseños de los perfiles, accesorios y guarniciones indicados en el presente catálogo están registrados.

Todos los datos mencionados en el presente catálogo son indicativos y no comprometen a **HYDRO ALUMINIUM ARGENTINA**.

En ningún caso **HYDRO ALUMINIUM ARGENTINA se hará responsable por las deficiencias constructivas de las aberturas fabricadas con sus perfiles.**

**HYDRO ALUMINIUM ARGENTINA** se reserva el derecho de realizar las modificaciones que considere necesarias con el fin de mejorar sus productos.

El material ilustrado en el presente catálogo es de propiedad exclusiva de **HYDRO ALUMINIUM ARGENTINA**, y está prohibida su reproducción, total o parcial, sin su expresa autorización.



## Notas Generales

# ROTONDA 640

<b>Perfiles de aluminio en aleación:</b>	AA6063.
<b>Temple:</b>	T6
<b>Tolerancias dimensionales y espesores:</b>	De acuerdo a norma IRAM 699. En el peso por metro +/-10% del nominal indicado en catálogo.

## CORREDIZA

<b>Hermeticidad al aire y agua:</b>	Por medio de felpas de polipropileno siliconado, con guarnición central de doble lámina de polipropileno semirígido.
<b>Aplicación del vidrio:</b>	En corredizas, vidrio contenido en perfil de hoja. En paños fijos, con contravidrios.
<b>Espesor del vidrio:</b>	Variable según medidas de las cuñas empleadas, colocando Doble Vidriado Hermético, máximo recomendado hasta 17 mm, utilizando cuña fina del lado interior y sellador exterior.
<b>Dimensiones básicas del sistema:</b>	Anchos de marcos: 64 y 101 mm. Ancho de la hoja: Corrediza: 27,4 mm.
<b>Tipologías:</b>	El sistema permite la realización de: <ul style="list-style-type: none"><li>• Puertas y ventanas corredizas, de 2, 3 y 4 hojas.</li><li>• Paños fijos.</li></ul>
<b>Características principales:</b>	<ul style="list-style-type: none"><li>• Corte de marco a 45° y ensamblado por medio de escuadras de tiraje mecánico de aluminio.</li><li>• Hojas armadas a 45° o alternativamente a 90°.</li><li>• Ensamblado de hojas armadas a 45° por medio de escuadras de tiraje mecánico de aluminio.</li><li>• Mecanizado sencillo, realizado con punzonadoras manuales o neumáticas.</li><li>• Carros regulables, montados sobre cojinetes a agujas, buje o bolillas, según dimensiones de la abertura y tipo de vidrio a utilizar.</li><li>• Marco con caja de agua.</li><li>• Refuerzos de parantes centrales para soportar grandes solicitaciones.</li></ul>



# ROTONDA 640

## Variantes:

El sistema permite una gran multiplicidad de variantes estéticas y/o funcionales.

- Marcos con colector de condensación, con y sin tapajunta.
- Hojas armadas a 90° con parantes centrales iguales a los laterales.
- Hojas armadas a 90° con parantes centrales distintos a los laterales.
- Hojas armadas a 45° para vidrio simple o Doble Vidriado Hermético.
- Existe, además, la posibilidad de incrementar el momento de inercia de los parantes centrales con los refuerzos ADR 400 y ADR 1515, con fijación oculta a tornillo.

## BATIENTE

### Hermeticidad al aire y agua:

Doble contacto, por medio de guarniciones de EPDM.

### Aplicación del vidrio:

En paños fijos, con contravidrios rectos o curvos.  
En batientes, hojas sin contravidrios.

### Espesor del vidrio:

Vidrio simple de 3 a 6 mm.  
Doble Vidriado Hermético hasta 17mm.

### Dimensiones básicas del sistema:

Ancho del marco: 64 mm, alternativa en 29 mm.  
Ancho de la hoja: 36 mm.  
Hoja coplanar al marco al exterior, sobrepuesta al interior.

### Tipologías:

El sistema permite la realización de:

- Ventanas de rebatir hacia el interior de 1, 2 y 3 hojas.
- Puertas de rebatir hacia el interior, de 1 y 2 hojas.
- Ventanas oscilo-batientes de 1 hoja, o combinadas con otra hoja de rebatir simple.
- Ventanas desplazables.
- Ventanas banderolas.
- Paños fijos.

### Características principales:

- Corte de marco y hoja a 45° y ensamblado por medio de escuadras de tiraje mecánico, de aluminio fundido a presión.
- Mecanizado sencillo, realizado con punzonadoras manuales o neumáticas.
- Contravidrios de paños fijos curvos o rectos.



## Especificaciones Técnicas

# ROTONDA 640

Paño fijo

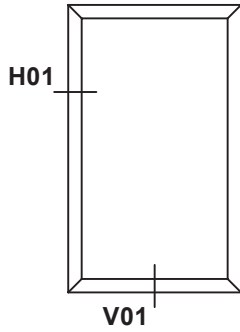

De rebatir

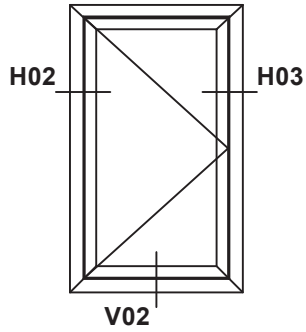

Oscilobatiente + Paño fijo

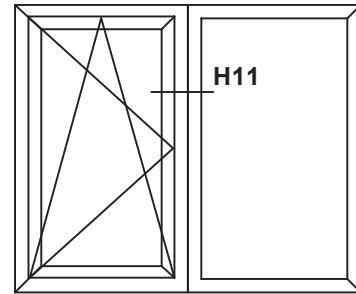

3 hojas de rebatir

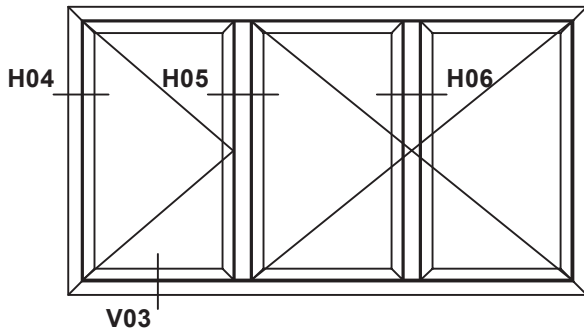

2 hojas de rebatir

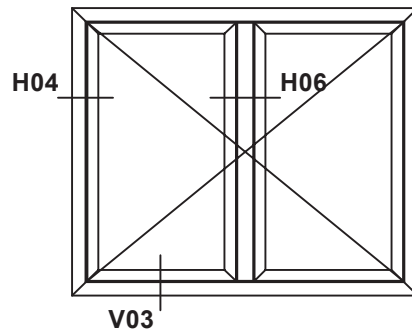

Puerta de rebatir de 2 hojas

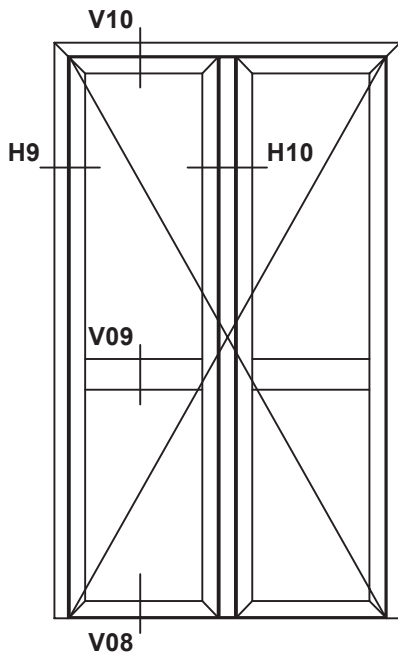

Puerta de rebatir

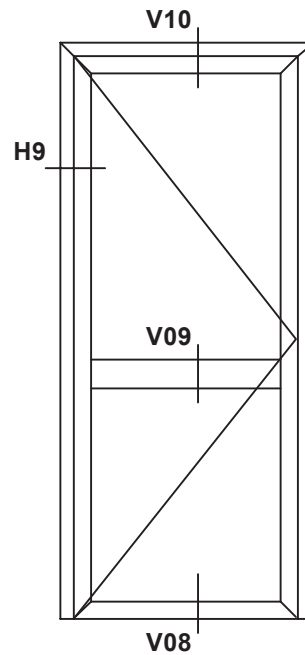

Esquema de Cortes Típicos

# ROTONDA 640

Corrediza de 2 hojas (corte a 90°)

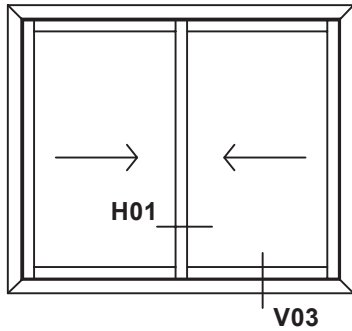

Corrediza de 3 hojas en 3 guías

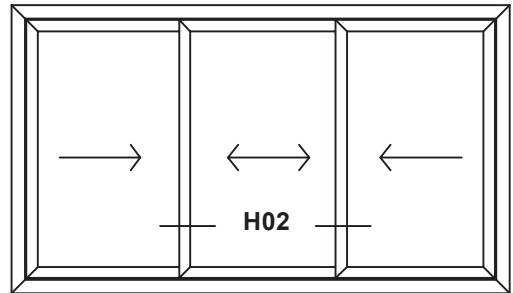

Corrediza de 2 hojas (corte a 45°)

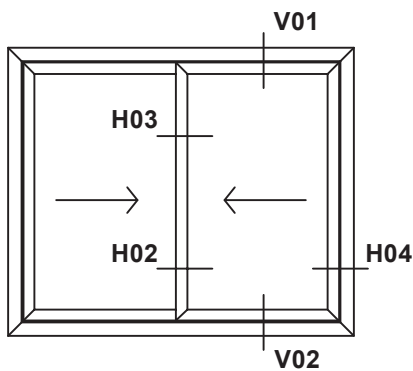

Corrediza de 3 hojas en 2 guías

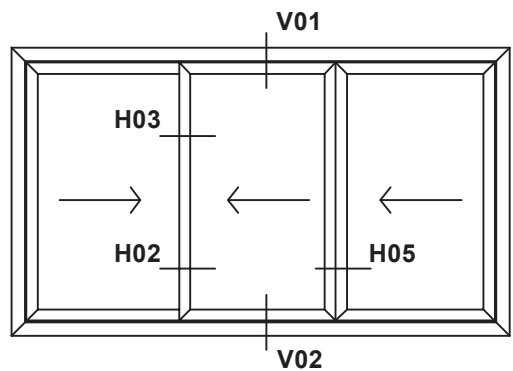

Corrediza de 4 hojas

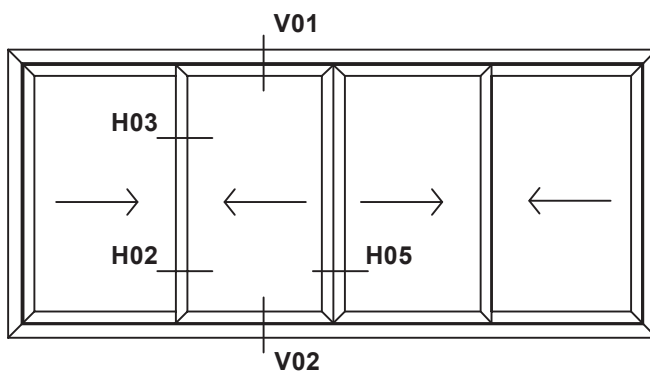

Corrediza + Paño fijo

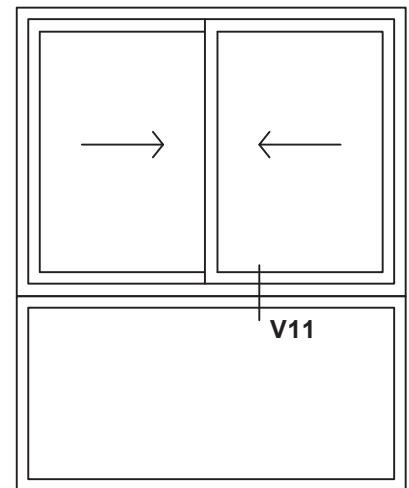

Banderola

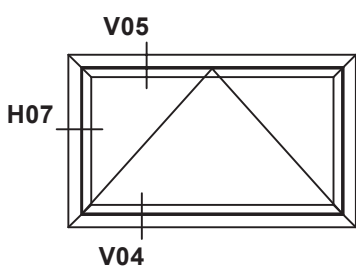



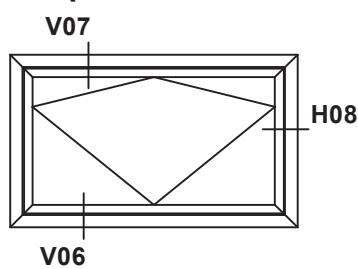











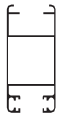

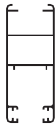



Desplazable

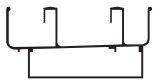

Esquema de Cortes Típicos

# ROTONDA 640

Código	Diseño	Descripción	kg/m	Código	Diseño	Descripción	kg/m
			Pág.				Pág.
ADR 11		Travesaño mosquitero	0,473	ADR 222		Encuentro central 4 hojas ADR 53A	0,181
			16				14
ADR 12		Mosquitero corredizo	0,277	ADR 232		Adaptador para DVH	0,289
			16				17
ADR 52A		Zócalo / Cabezal hoja corte a 90°	0,593	ADR 230		Premarco	0,436
			14				26
ADR 53A		Parante lateral hoja corte a 90°	0,645	ADR 255		Vierteaguas	0,201
			14				23
ADR 54		Parante central hoja corte a 90°	0,498	ADR 261		Hoja corte a 45° para vidrio simple	0,676
			14				15
ADR 55		Vidrio repartido central	0,382	ADR 262		Cierre de enclipar ADR 261 / 366 / 425	0,312
			17				16
ADR 56A		Vidrio repartido lateral	0,264	ADR 292		Zócalo alto / travesaño	1,081
			17				14
ADR 62		Tapajuntas chico	0,256	ADR 293		Tapacinta	0,410
			24				26
ADR 63		Marco	0,960	ADR 294		Guía de cortina	0,414
			12				17
ADR 172A		Cierre de enclipar ADR 53A	0,320	ADR 357		Perimetral vidrio repartido	0,250
			16				17
ADR 191		Tapajuntas	0,410	ADR 358		Travesaño vidrio repartido	0,336
			24				17



## Indice de Perfiles











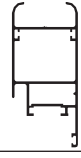
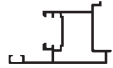
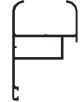

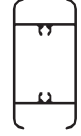

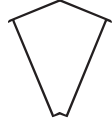
# ROTONDA 640

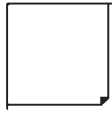
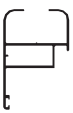
Código	Diseño	Descripción	kg/m	Código	Diseño	Descripción	kg/m
			Pág.				Pág.
ADR 366		Hoja corte a 45° "pecho paloma"	0,593	ADR 914		Contravidrio curvo de 12 mm	0,209
			15				23
ADR 374		Marco con tapajuntas	1,058	ADR 915		Contravidrio para clip de 12 mm	0,147
			13				23
ADR 400		Refuerzo de parante central	1,042	ADR 922		Pletina	0,139
			16				23
ADR 425		Hoja corte a 45° para DVH	0,697	ADR 1160		Marco de 64 mm	0,766
			15				18
ADR 558		Mosquitero reforzado	0,634	ADR 1161		Marco de 29 mm	0,509
			16				19
ADR 561		Tapajuntas	0,478	ADR 1162		Hoja ventana batiente para vidrio simple	0,669
			24				20
ADR 761		Premarco	0,372	ADR 1163		Contravidrio recto de 16 mm	0,227
			26				23
ADR 910		Contravidrio recto de 8 mm	0,211	ADR 1164		Tapajuntas	0,145
			23				24
ADR 911		Contravidrio curvo de 8 mm	0,203	ADR 1165		Perfil unión de 64 mm	0,364
			23				24
ADR 912		Contravidrio para clip de 8 mm	0,134	ADR 1166		Hoja puerta para vidrio simple	1,036
			23				21
ADR 913		Contravidrio recto de 16 mm	0,216	ADR 1167		Travesaño puerta para vidrio simple	0,950
			23				21

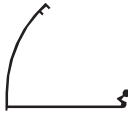
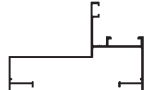

## Indice de Perfiles

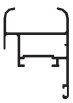
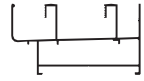

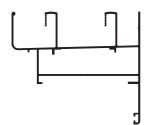



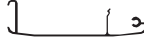
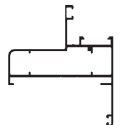

# ROTONDA 640

Código	Diseño	Descripción	kg/m	Código	Diseño	Descripción	kg/m
			Pág.				Pág.
ADR 1168		Travesaño paño fijo	0,811	ADR 1179		Hoja puerta para DVH	1,050
			22				21
ADR 1169		Postizo doble hoja	0,684	ADR 1180		Hoja proyectante para DVH	0,612
			22				20
ADR 1170		Portafelpas puerta	0,238	ADR 1181		Travesaño puerta para DVH	0,944
			22				21
ADR 1171		Marco proyectante de 64 mm	0,708	ADR 1338		Columna 45°	0,775
			18				25
ADR 1172		Marco proyectante de 29 mm	0,452	ADR 1339		Columna 90°	1,060
			19				25
ADR 1173		Hoja proyectante para vidrio simple	0,613	ADR 1379		Zócalo / travesaño bajo	0,824
			20				14
ADR 1174		Contra vidrio curvo de 16 mm	0,220	ADR 1381		Guía cortina barrio	0,753
			23				17
ADR 1175		Contra vidrio para clip de 16 mm	0,160	ADR 1498		Rótula exterior	0,594
			23				25
ADR 1176		Marco 75 mm	0,700	ADR 1499		Rótula interior	0,525
			22				25
ADR 1177		Hoja ventana batiente para DVH	0,658	ADR 1510		Marco	1,010
			20				12
ADR 1178		Contra vidrio para DVH	0,147	ADR 1511		Marco con tapajunta	1,130
			23				13

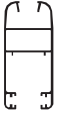
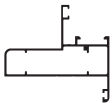

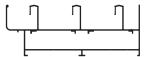
## Indice de Perfiles

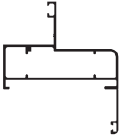
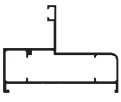
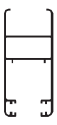
# ROTONDA 640

Código	Diseño	Descripción	kg/m	Código	Diseño	Descripción	kg/m
			Pág.				Pág.
ADR 1512		Marco de 64 mm	0,830	ADR 1653		Tapacinta	0,628
			18				26
ADR 1513		Marco de 64 mm con tapajuntas	0,952	ADR 1662		Tapajuntas	0,277
			19				24
ADR 1514		Hoja corte a 45° para vidrio simple	0,700	ADR 1800		Marco de 64 mm con tapajuntas	0,861
			15				19
ADR 1515		Refuerzo de parante central	1,100	ADR 1874		Marco de 101 mm de 3 guías	1,430
			16				12
ADR 1516		Cierre de enclipar ADR 1514 / 1650	0,290				
			16				
ADR 1517		Tapajuntas	0,180				
			24				
ADR 1648		Marco proyectante con tapajuntas	0,892				
			19				
ADR 1649		Marco 64 mm proyectante	0,773				
			18				
ADR 1650		Hoja corte a 45° para DVH	0,650				
			15				
ADR 1651		Encuentro central 4 hojas	0,180				
			15				
ADR 1652		Bisagra tapacinta	0,365				
			26				

# ROTONDA 640

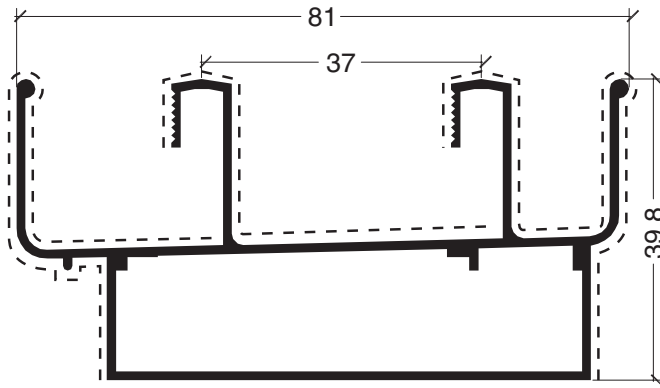

ADR 63 Marco  
0,960 kg/m



Escuadra AA201

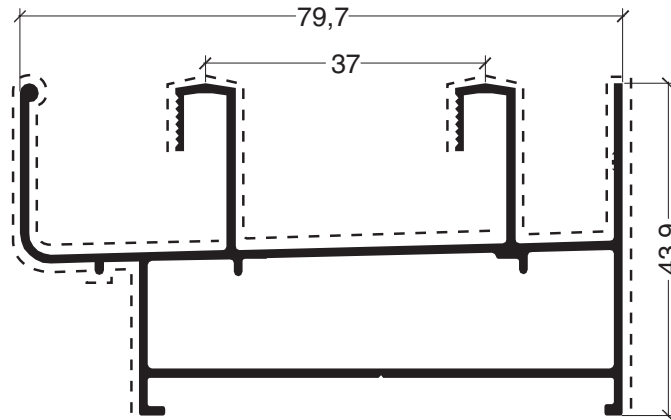

ADR 1510 Marco  
1,010 kg/m



Escuadra AA255

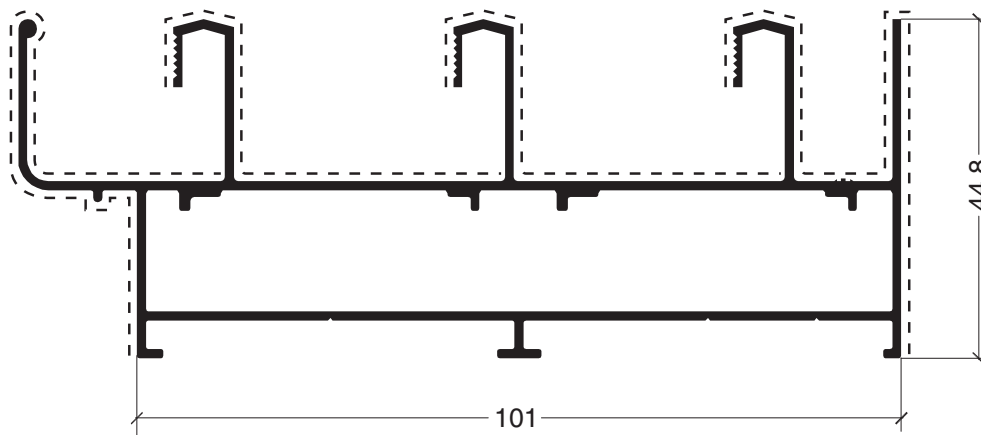

ADR 1874 Marco de 3 guías  
1,430 kg/m



2 Escuadras AA255

--- Cara Vista



## Perfiles (Escala 1:1)

# ROTONDA 640

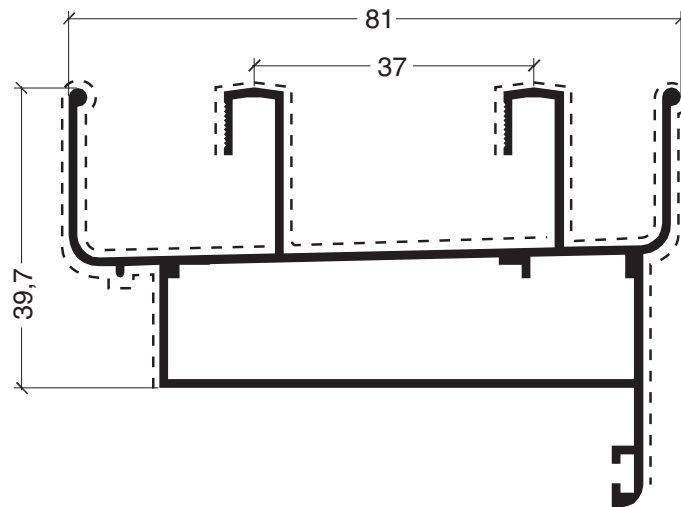

ADR 374 Marco con tapajuntas  
1,058 kg/m



Escuadra AA201

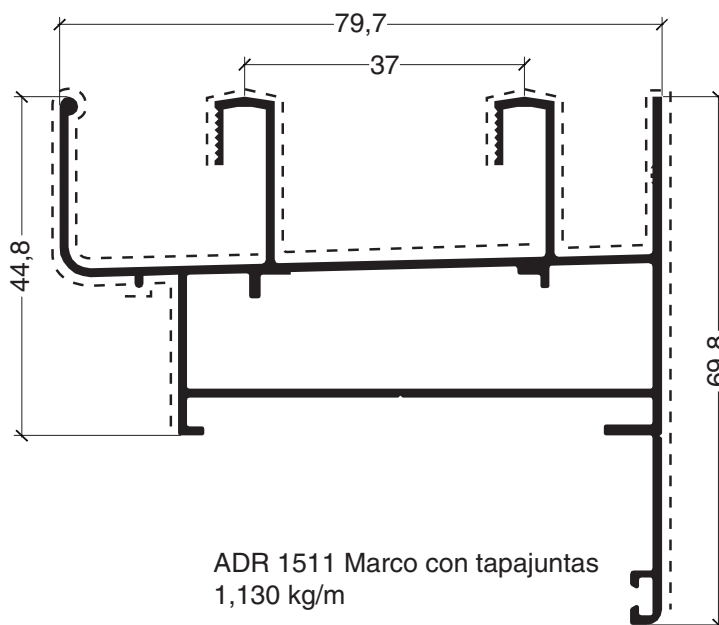

ADR 1511 Marco con tapajuntas  
1,130 kg/m



Escuadra AA255

----- Cara Vista

# ROTONDA 640

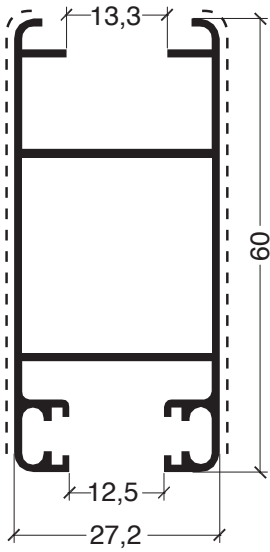

ADR 53A Parante lateral  
hoja corte a 90°  
0,645 kg/m

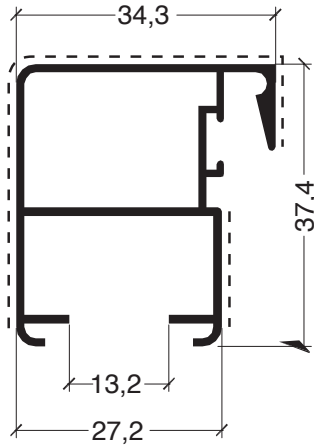

ADR 54 Parante central  
hoja corte a 90°  
0,498 kg/m

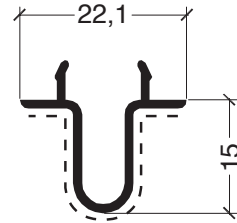

ADR 222 Encuentro  
central 4 hojas  
0,181 kg/m  
Exclusivo ADR 53A

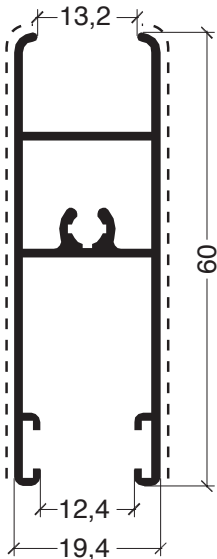

ADR 52A Zócalo/Cabezal  
hoja corte a 90°  
0,593 kg/m

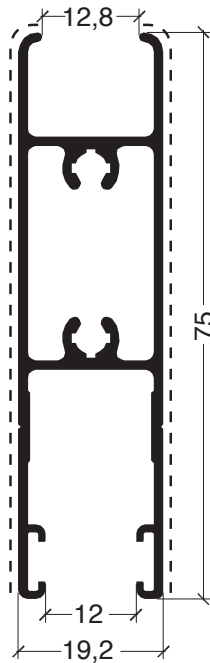

ADR 1379  
Zócalo/travesaño bajo  
0,824 kg/m

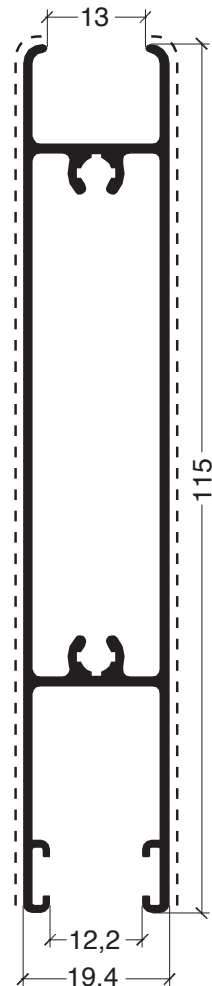

ADR 292  
Zócalo alto /travesaño  
1,081 kg/m

--- Cara Vista



Perfiles (Escala 1:1)

# ROTONDA 640

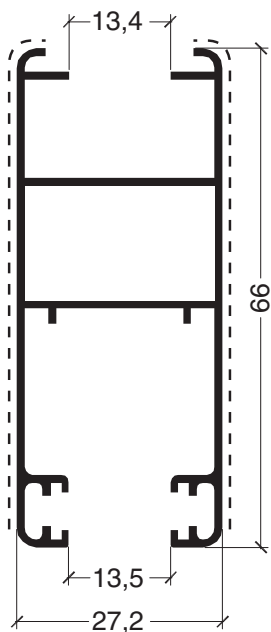

ADR 261 Hoja corte a 45°  
para vidrio simple  
0,676 kg/m



Escuadra AA207

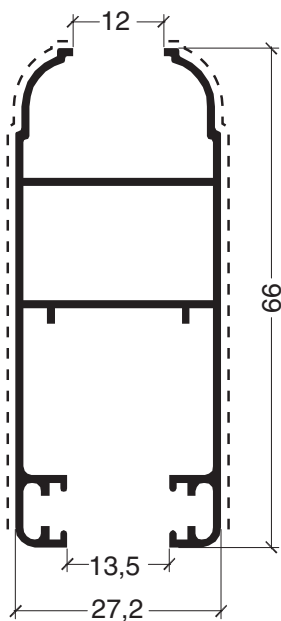

ADR 366 Hoja corte a 45°  
"pecho paloma"  
0,593 kg/m



Escuadra AA207

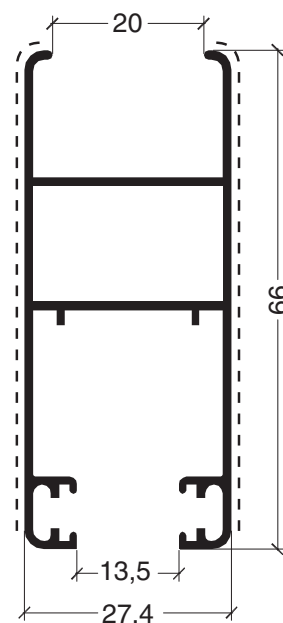

ADR 425 Hoja corte a 45°  
para DVH  
0,697 kg/m



Escuadra AA207

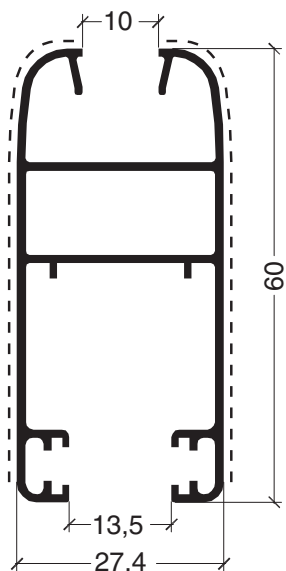

ADR 1514 Hoja corte a 45°  
para vidrio simple  
0,700 kg/m



Escuadra AA256

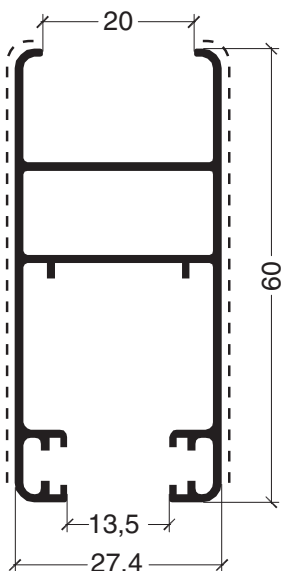

ADR 1650 Hoja corte a 45°  
para DVH  
0,650 kg/m



Escuadra AA256

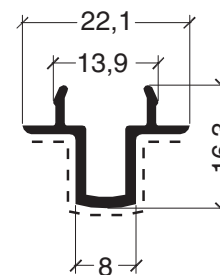

ADR 1651 Encuentro  
central 4 hojas  
0,180 kg/m

--- Cara Vista



Perfiles (Escala 1:1)

# ROTONDA 640

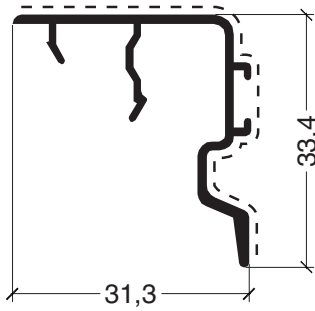

ADR 172A Cierre de enclipar  
para ADR 53A  
0,320 kg/m

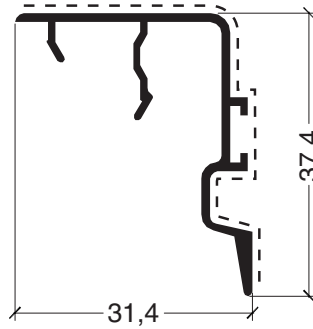

ADR 262 Cierre de enclipar  
para ADR 261 / 366 / 425  
0,309 kg/m

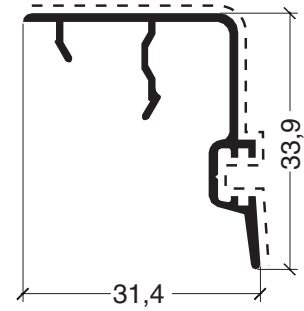

ADR 1516 Cierre de enclipar  
para ADR 1514 / 1650  
0,290 kg/m

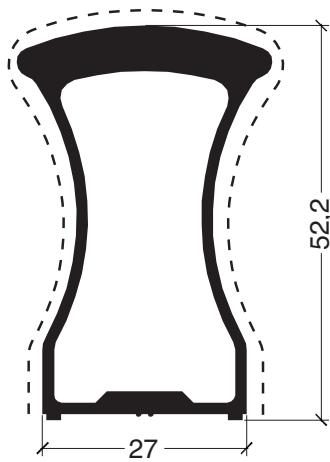

ADR 400 Refuerzo de  
parante central  
1,042 kg/m

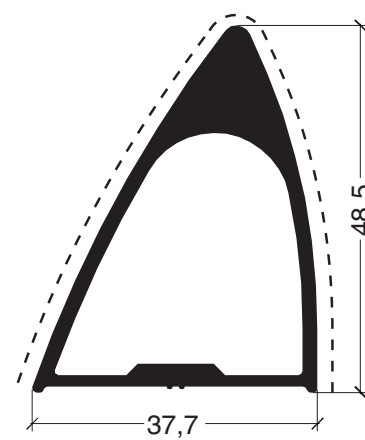

ADR 1515 Refuerzo de  
parante central  
1,100kg/m

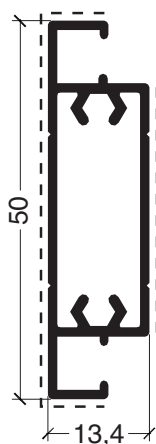

ADR 11 Trav. mosquitero  
0,473 kg/m

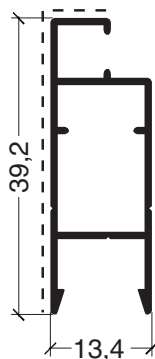

ADR 12 Mosquitero  
0,277 kg/m

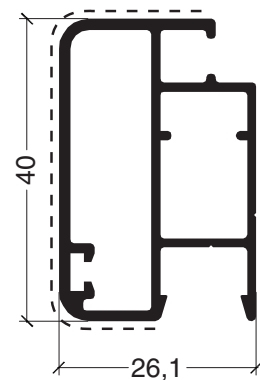

ADR 558 Mosq. reforzado  
0,634 kg/m

----- Cara Vista



**Perfiles (Escala 1:1)**

# ROTONDA 640

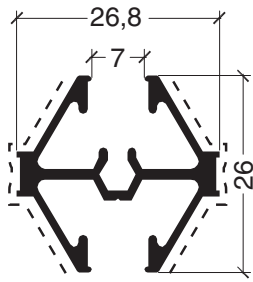

ADR 55 Travesaño  
vidrio repartido  
0,382 kg/m

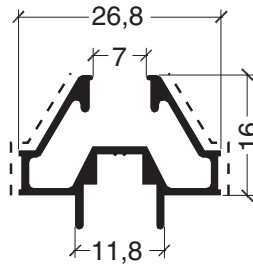

ADR 56A Perimetral  
vidrio repartido  
0,264 kg/m

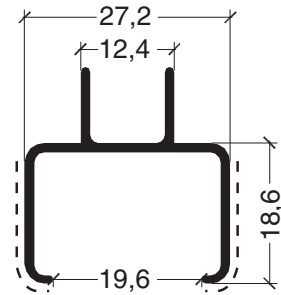

ADR 232 Adaptador  
para DVH  
0,289 kg/m

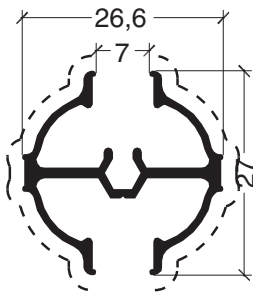

ADR 358 Travesaño vidrio  
repartido "pecho paloma"  
0,336 kg/m

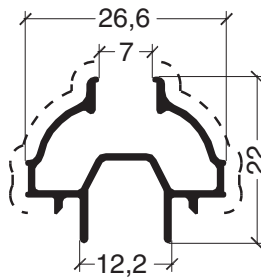

ADR 357 Perimetral vidrio  
repartido "pecho paloma"  
0,250 kg/m

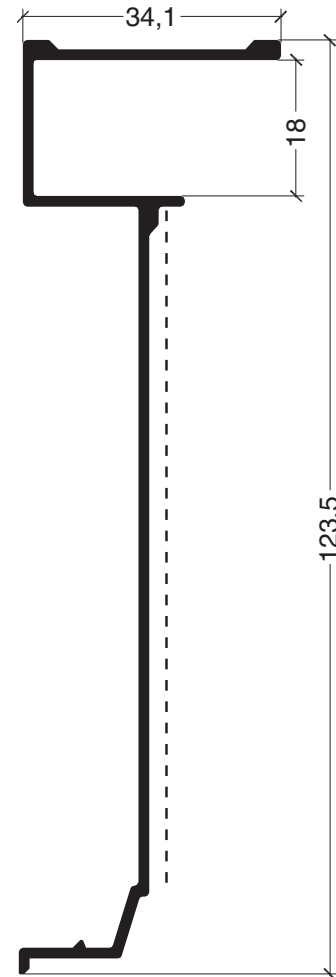

ADR 1381 Guía cortina barro  
0,753 kg/m

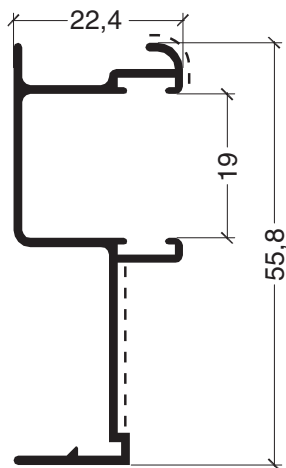

ADR 294 Guía cortina común  
0,414 kg/m

----- Cara Vista



**Perfiles (Escala 1:1)**

# ROTONDA 640

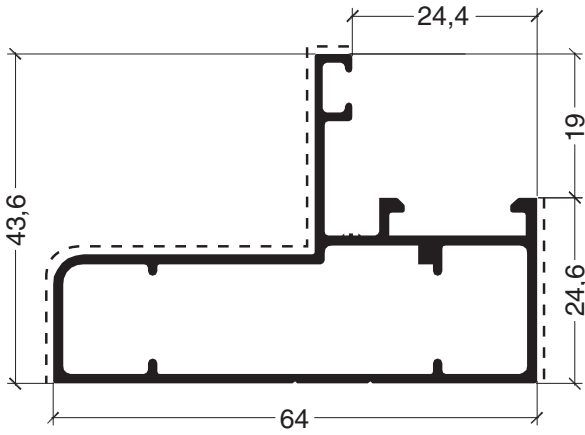

ADR 1160 Marco 64 mm  
0,766 kg/m



Escuadra AA255

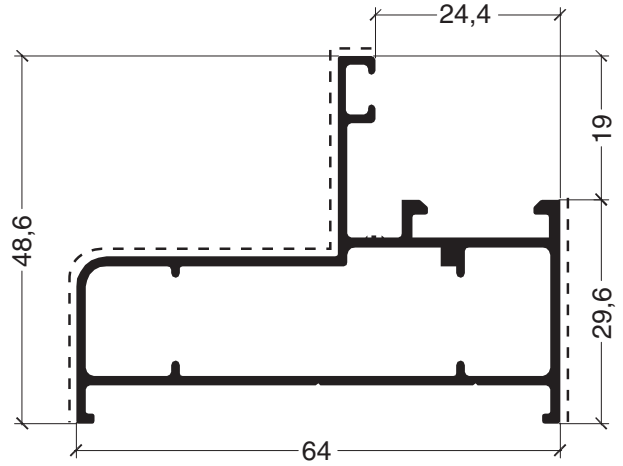

ADR 1512 Marco 64 mm  
0,830 kg/m



Escuadra AA255

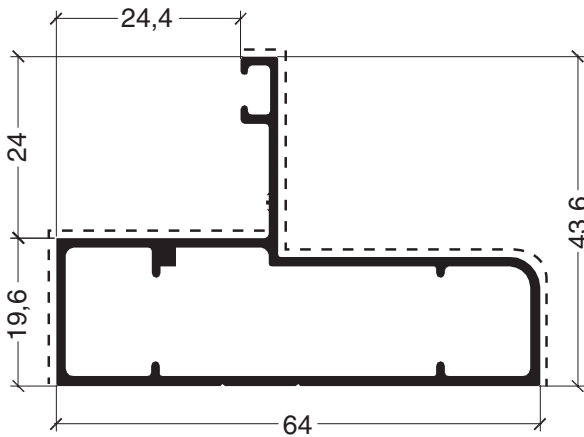

ADR 1171 Marco Proyectante 64 mm  
0,708 kg/m



Escuadra AA255

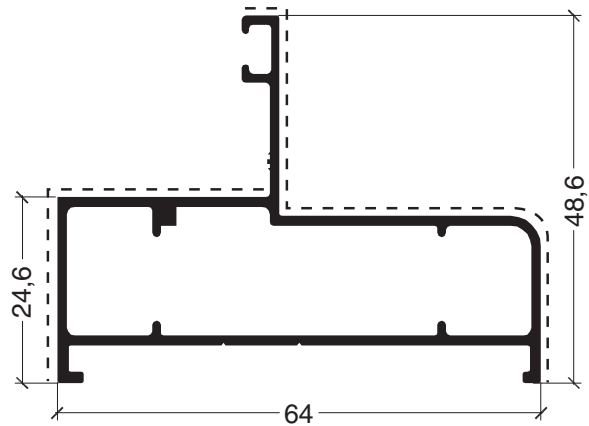

ADR 1649 Marco Proyectante 64 mm  
0,773 kg/m



Escuadra AA255

----- Cara Vista



**Perfiles (Escala 1:1)**

# ROTONDA 640

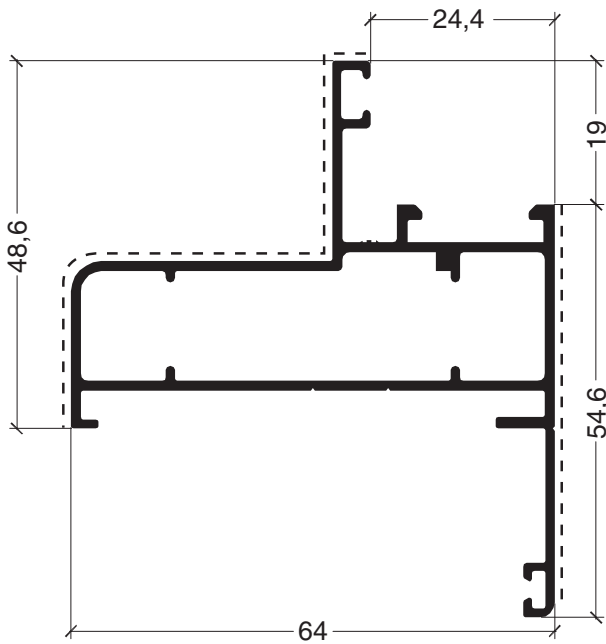

ADR 1513 Marco 64 mm  
con tapajuntas  
0,952 kg/m



Escuadra AA255

ADR 1161 Marco 29 mm  
0,509 kg/m



Escuadra AA256

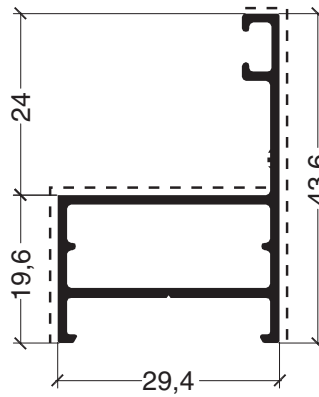
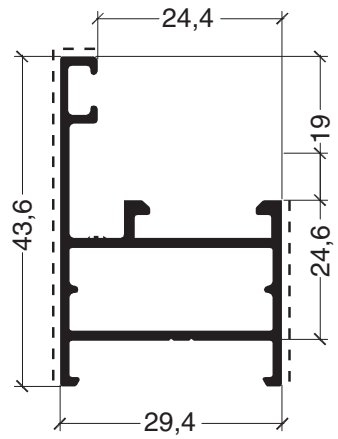

ADR 1172 Marco  
Proyectante 29 mm  
0,452 kg/m



Escuadra AA256

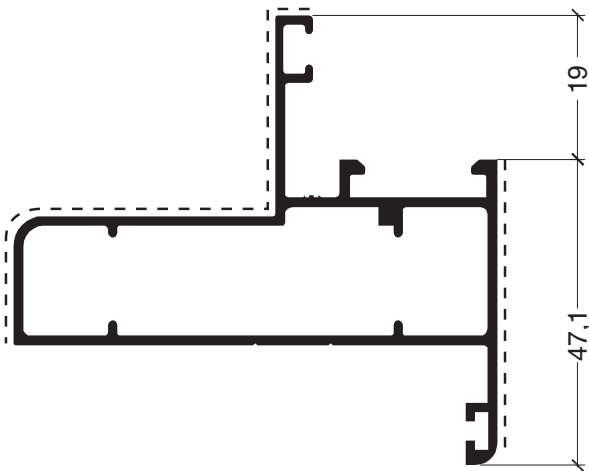

ADR 1800 Marco 64 mm  
con tapajuntas  
0,861 kg/m



Escuadra AA255

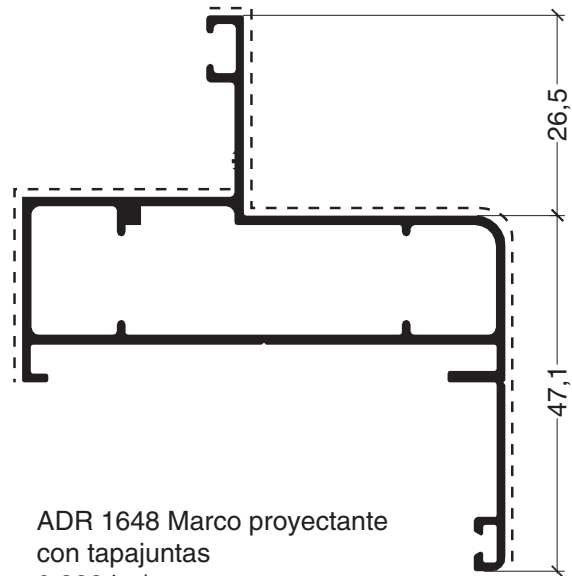

ADR 1648 Marco proyectante  
con tapajuntas  
0,892 kg/m



Escuadra AA255

--- Cara Vista



Perfiles (Escala 1:1)

# ROTONDA 640

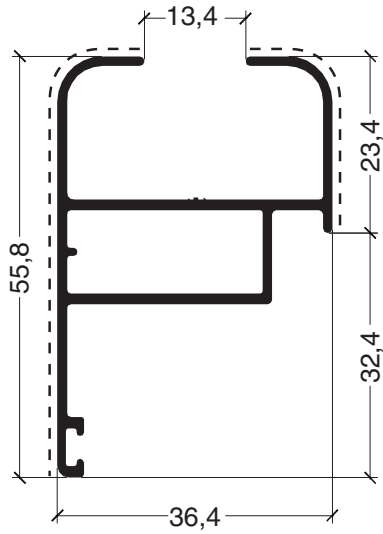

ADR 1173 Hoja Ventana Proyectante  
para Vidrio Simple  
0,613 kg/m



Escuadra AA256

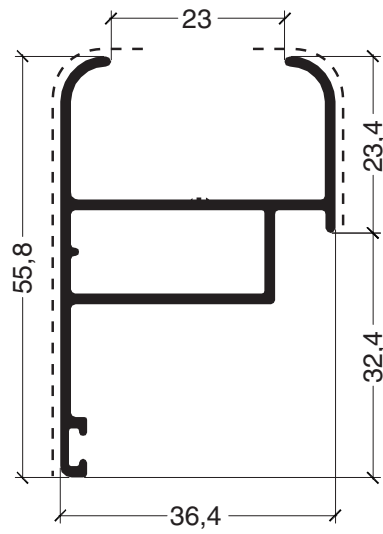

ADR 1180 Hoja Ventana Proyectante  
para Doble Vidriado Hermético  
0,612 kg/m



Escuadra AA256

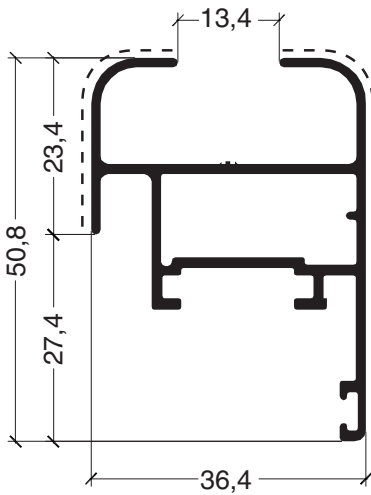

ADR 1162 Hoja Ventana Batiente  
para Vidrio Simple  
0,669 kg/m



Escuadra AA256

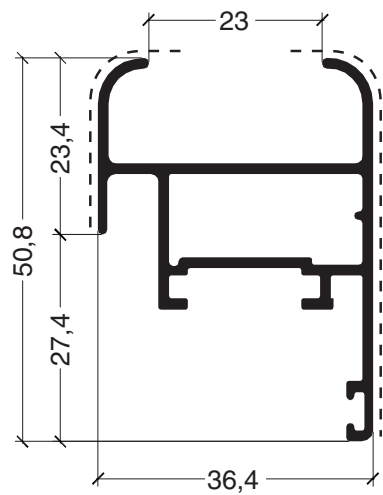

ADR 1177 Hoja Ventana Batiente  
para Doble Vidriado Hermético  
0,658 kg/m



Escuadra AA256

--- Cara Vista



Perfiles (Escala 1:1)

# ROTONDA 640

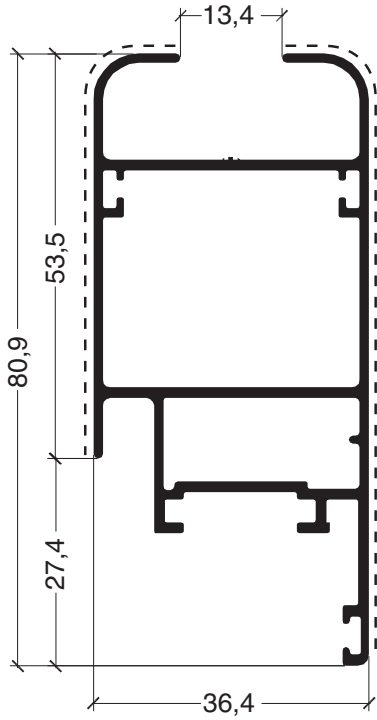

ADR 1166 Hoja Puerta  
para Vidrio Simple  
1,036 kg/m



Escuadra AA256  
Alineamiento AA 107

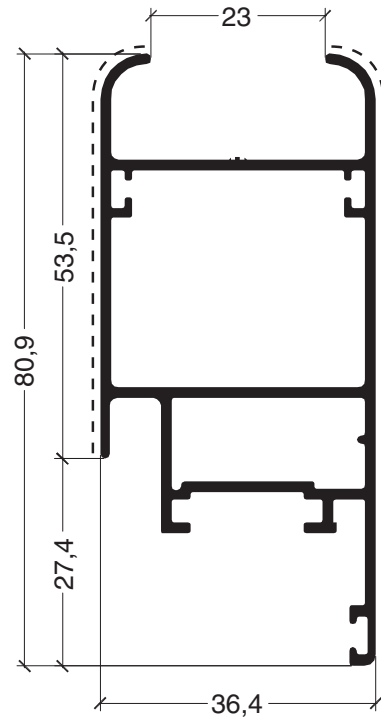

ADR 1179 Hoja Puerta  
para Doble Vidriado Hermético  
1,050 kg/m



Escuadra AA256  
Alineamiento AA 107

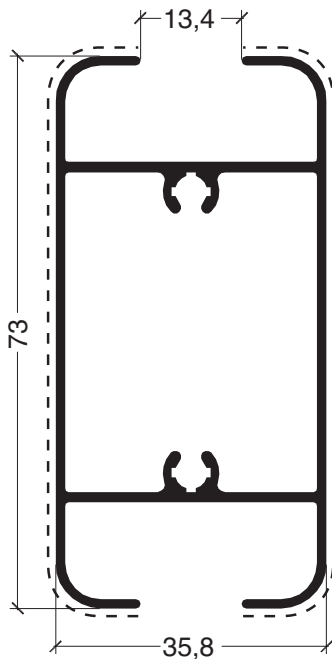

ADR 1167 Travesaño Puerta  
para Vidrio Simple  
0,950 kg/m

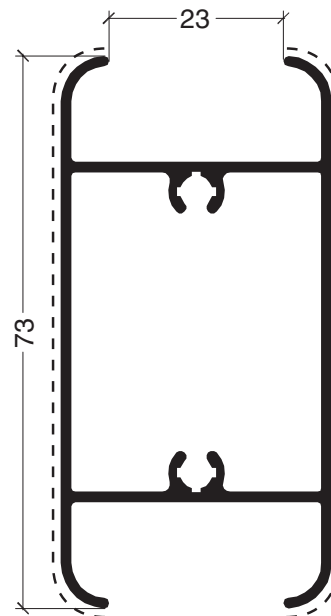

ADR 1181 Travesaño Puerta  
para Doble Vidriado Hermético  
0,944 kg/m

----- Cara Vista



Perfiles (Escala 1:1)

# ROTONDA 640

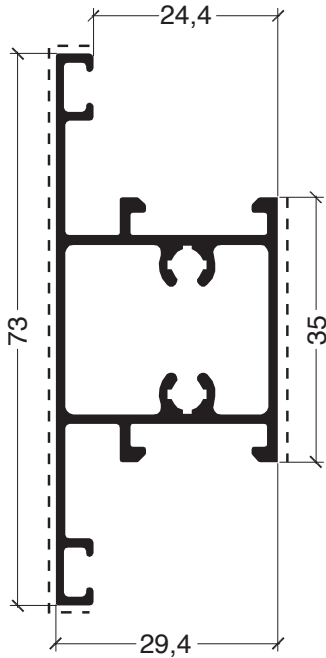

ADR 1168 Travesaño Paño Fijo  
0,811 kg/m

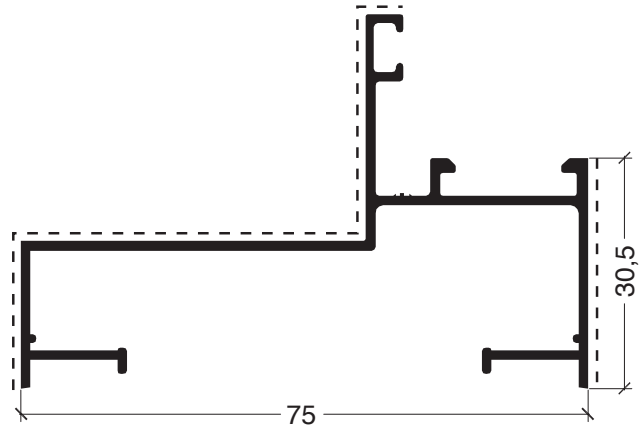

ADR 1176 Marco 75 mm  
0,700 kg/m - L = 6170 mm.



Escuadra AA501

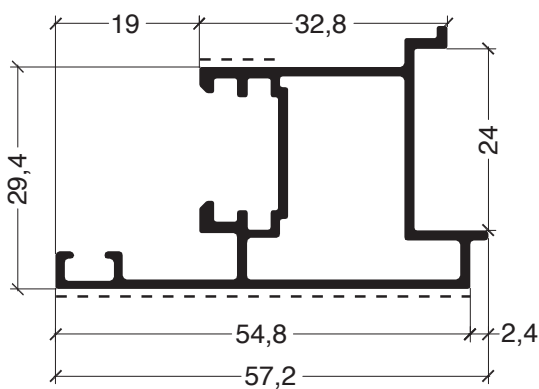

ADR 1169 Postizo doble hoja  
0,684 kg/m

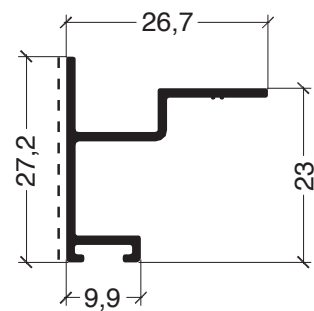

ADR 1170 Portafelpas Puerta  
0,238 kg/m

----- Cara Vista



**Perfiles (Escala 1:1)**

# ROTONDA 640

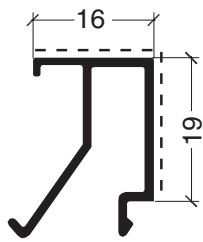

ADR 1163  
Contravidrio recto 16 mm  
0,227 kg/m

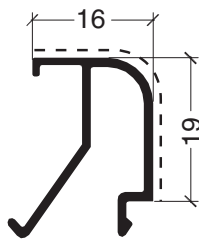

ADR 1174  
Contravidrio curvo 16 mm  
0,220 kg/m

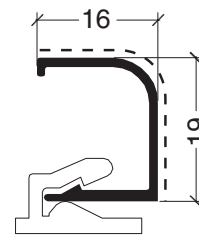

ADR 1175  
Contravidrio curvo p/ clip 16 mm  
0,160 kg/m

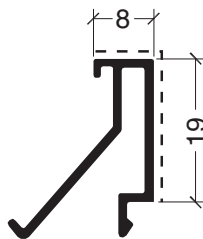

ADR 910  
Contravidrio recto 8 mm  
0,211 kg/m

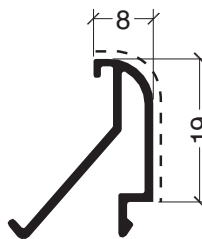

ADR 911  
Contravidrio curvo 8 mm  
0,203 kg/m

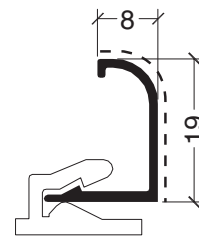

ADR 912  
Contravidrio p/ clip 8 mm  
0,134 kg/m

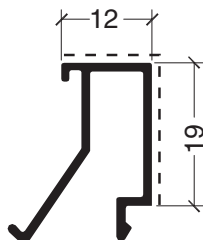

ADR 913  
Contravidrio recto 12 mm  
0,216 kg/m

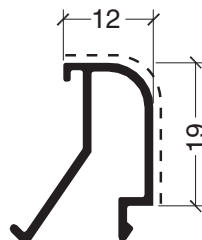

ADR 914  
Contravidrio curvo 12 mm  
0,209 kg/m

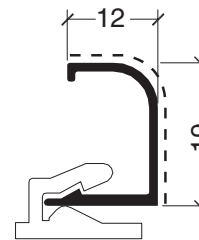

ADR 915  
Contravidrio p/ clip 12 mm  
0,147 kg/m

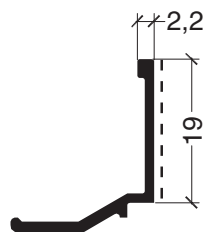

ADR 1178 Contravidrio para DVH  
0,147 kg/m

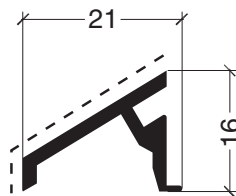

ADR 255 Vierendeel  
0,201 kg/m

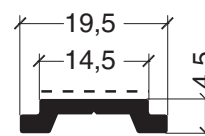

ADR 922 Pletina  
0,139 kg/m

----- Cara Vista



Perfiles (Escala 1:1)

# ROTONDA 640

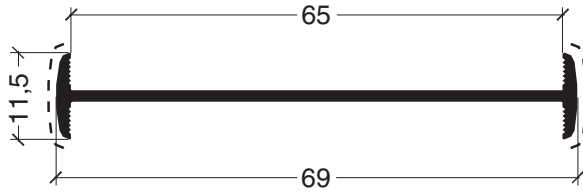

ADR 1165 Perfil de unión 64 mm  
0,364 kg/m

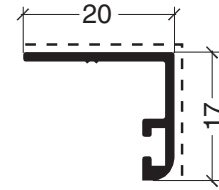

ADR 1164 Tapajuntas  
0,145 kg/m

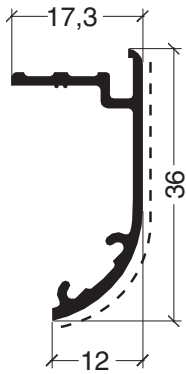

ADR 62 Tapajuntas  
chico  
0,256 kg/m

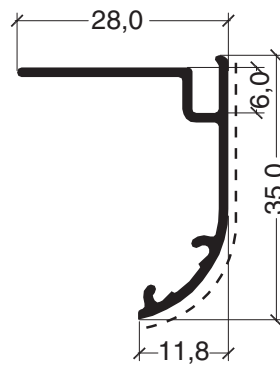

ADR 1662 Tapajuntas  
0,277 kg/m

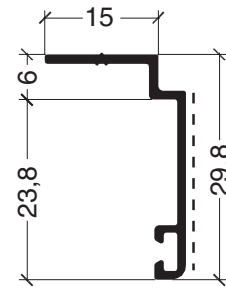

ADR 1517 Tapajuntas  
0,180 kg/m

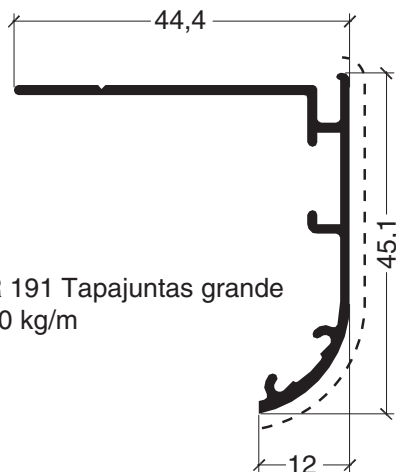

ADR 191 Tapajuntas grande  
0,410 kg/m

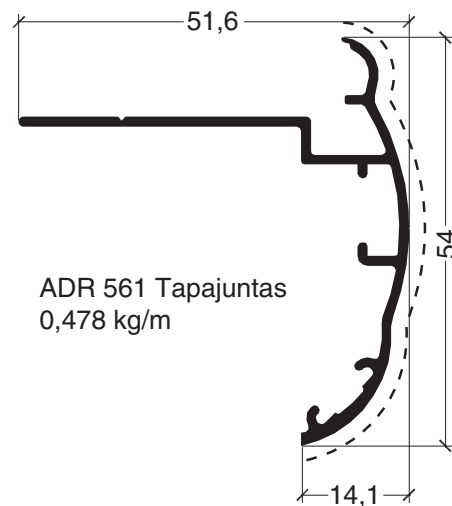

ADR 561 Tapajuntas  
0,478 kg/m

--- Cara Vista



**Perfiles (Escala 1:1)**

# ROTONDA 640

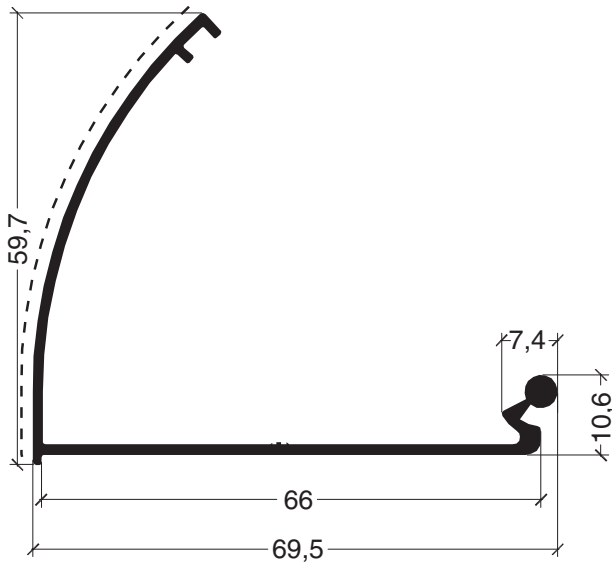

ADR 1498 Rótula exterior  
0,594 kg/m

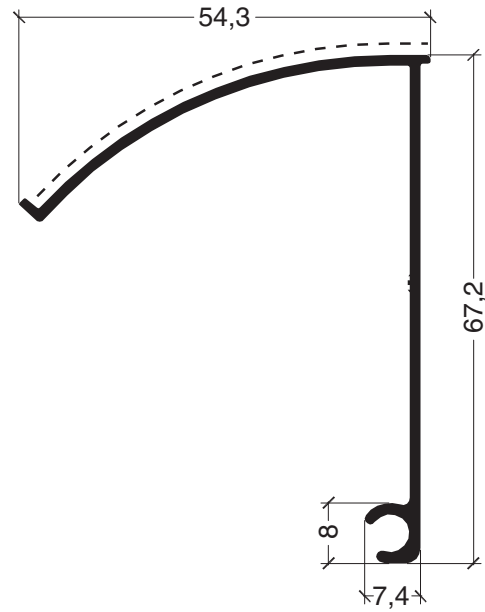

ADR 1499 Rótula interior  
0,525 kg/m

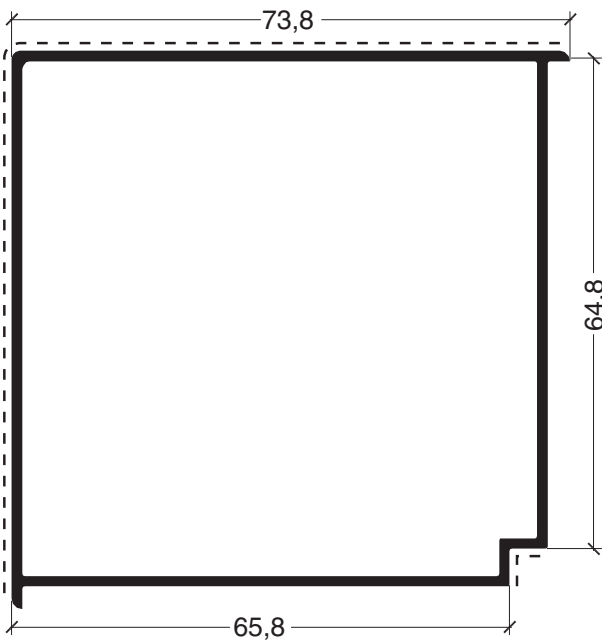

ADR 1339 Columna 90°  
1,060 kg/m

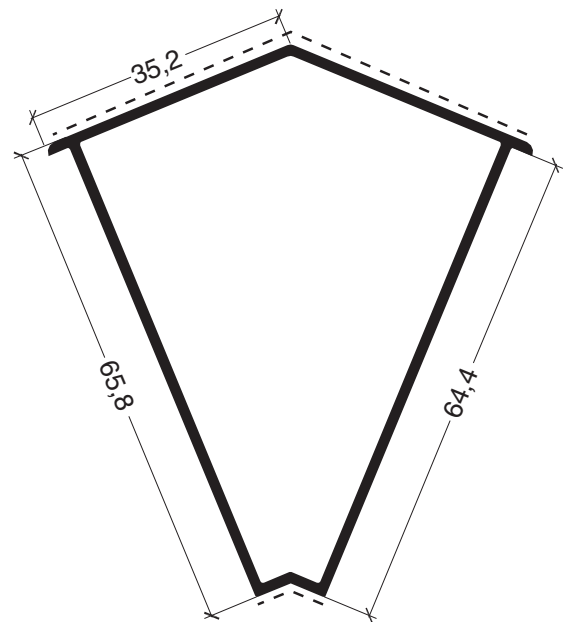

ADR 1338 Columna 45°  
0,775 kg/m

----- Cara Vista



**Perfiles (Escala 1:1)**

# ROTONDA 640

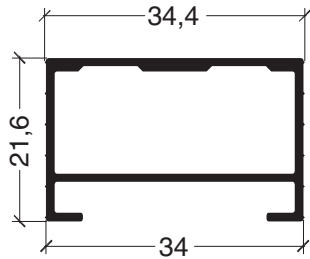

ADR 761 Premarco  
0,372 kg/m

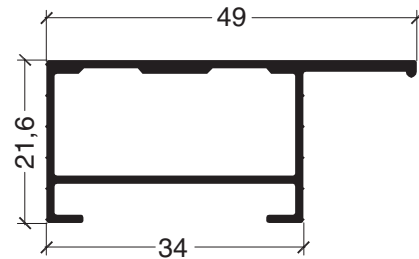

ADR 230 Premarco  
0,436 kg/m

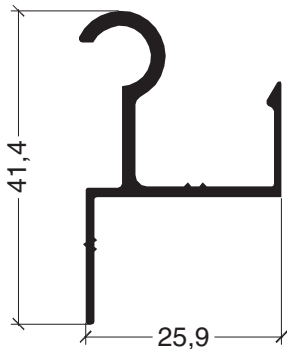

ADR 1652 Bisagra tapacinta  
0,365 kg/m

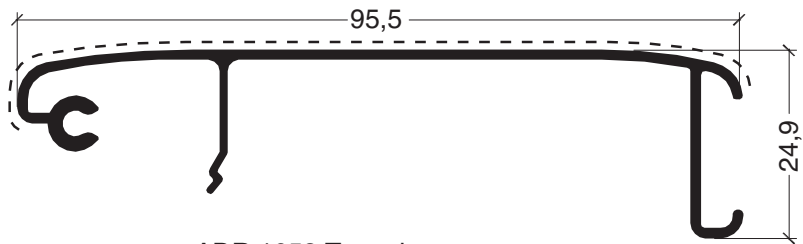

ADR 1653 Tapacinta  
0,628 kg/m

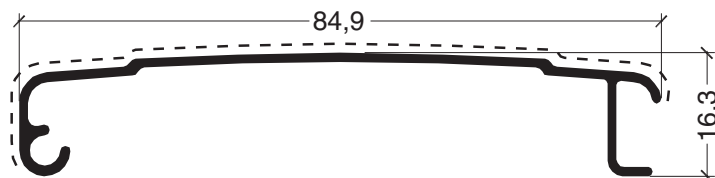











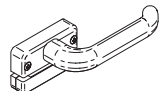

ADR 293 Tapacinta  
0,410 kg/m

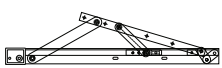
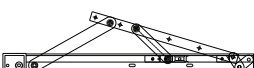
--- Cara Vista



**Perfiles (Escala 1:1)**



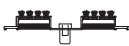









# ROTONDA 640

Código	Diseño	Descripción	Color	Material
AA008		Escuadra alineación tapajunta		Acero
AA014		Tapa desagüe	Negro	Plástico
AA035		Aldaba ventana desplazable		Fundición
AA107		Escuadra alineamiento hoja		Hierro galvanizado
AA125		Tijera para desplazable de 400 mm		Acero inox.
AA126		Tijera para desplazable de 550 mm		Acero inox.
AA201		Escuadra de tracción para marcos ADR 63 / 374		Aluminio
AA202		Pieza guía hoja	Negro	Poliamida
AA203		Cierre lateral		Aluminio
AA204		Rueda		Poliamida
AA205		Tapón parante lateral ADR 53	Negro	Poliamida
AA206		Tapón parante central ADR 54	Negro	Poliamida
AA207	 opcional E8	Escuadra de tracción para hoja ADR 261		Aluminio
AA208		Escuadra alineación para hoja		Poliamida
AA209		Cortavientos		Aluminio

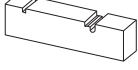
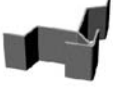

## Accesorios

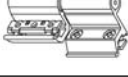









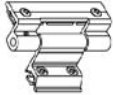

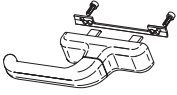
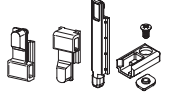
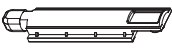
# ROTONDA 640

Código	Diseño	Descripción	Color	Material
AA210		Tope de hojas	Negro	Poliamida
AA211		Tapa parante	Negro	Poliamida
AA212		Tapón caja de agua para ADR 63 / 374	Negro	Poliamida
AA213		Tornillo de armado 10 x 1 1/2		Acero inox.
AA214		Boca de desagüe caja de agua	Negro	Poliamida
AA215		Rueda a rodillo		Poliamida
AA226		Tapón caja de agua para ADR 1510	Negro	Poliamida
AA250		Escuadra de premarco	Negro	Poliamida
AA251 AA252 AA253		Calce 3 mm para vidrios Calce 4 mm para vidrios Calce 5 mm para vidrios	Negro	Plástico
AA254		Encuentro central doble hoja	Negro	Plástico
AA255		Escuadra para marcos de 64 mm (botón 10 mm)		Aluminio
AA256		Escuadra para marcos de 29 mm		Aluminio
AA257		Bisagra de dos cuerpos no coplanar (tipo H 61)		Aluminio, acero y poliamida
AA258		Bisagra de dos cuerpos de 3º hoja coplanar (tipo H 81)		Aluminio, acero y poliamida
AA259		Bisagra de tres cuerpos no coplanar (tipo H 62)		Aluminio, acero y poliamida

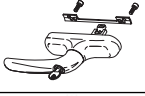

## Accesorios

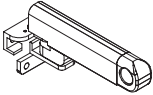









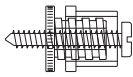

# ROTONDA 640

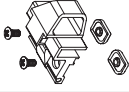
Código	Diseño	Descripción	Color	Material
AA260		Bisagra de tres cuerpos de 3º hoja coplanar (tipo H 82)		Aluminio, acero y poliamida
AA261		Limitador de apertura banderola		Aluminio, acero y poliamida
AA262-1		Falleba ventana de abrir		Aluminio, acero Zamak y plástico
AA262-2		Kit para falleba		Poliamida c/F.V., acero inox.
AA263		Pasador 2º hoja ventana		Poliamida c/F.V., Zamak, Ac. galv.
AA264		Pasador 2º hoja puerta		Poliamida c/F.V., Zamak, Ac. galv.
AA265-1		Mecanismo oscilobatiente base		Aluminio, Zamak, Acero inox.
AA265-2		Brazo tipo 1		Zamak
AA265-3		Brazo tipo 2		Zamak
AA265-4		Falleba para oscilobatiente		Aluminio, acero Zamak y plástico
AA265-5		Brazo suplementario		Zamak
AA265-6		Cierre suplementario horizontal		Zamak
AA265-7		Cierre suplementario vertical		Zamak
AA266		Brazo de empuje ventiluz		Aluminio
AA267		Limitador apertura batiente		Hierro galvan



## Accesorios















# ROTONDA 640

Código	Diseño	Descripción	Color	Material
AA268		Manija doble balancín		Ac. inox.
AA269		Taco regulador marco-premarco		Aluminio, plástico
AA270		Tornillo 10 x 1 1/2" armado travesaño		Hierro galvan.
AA271		Tapa tornillo puerta		Hierro galvan.
AA272		Clip contravidrios redondeado		Plástico
AA273		Cerradura para puerta		
AA274		Cierre banderola en cámara		Aluminio, poliamida, acero galv.
AA275		Traba varilla y 3º cierre		Poliamida, ac.inox.
AA276		Terminal pasador a piso		Bronce pulido
AA501		Escuadra 71 mm.		Aluminio
AA503		Rueda para ADR 52		Poliamida
AA504		Aldaba		Alumino, acero y poliamida
AA530		Escuadra mosquitero		Aluminio
AH095		Llave Allen de 2,5 mm.		
AH098		Llave Allen de 5 mm.		



**Accesorios**

# ROTONDA 640

Código	Diseño	Descripción	Material
AG001S		Felpa 7 x 6 con fin seal	EPDM
AG002E		Burlete U universal chico	EPDM
AG003E		Burlete U universal mediano	EPDM
AG004E		Burlete U universal grande	EPDM
AG005E		Burlete para paño fijo	EPDM
AG043E		Burlete cuña grande	EPDM
AG044E		Burlete cuña mediano	EPDM
AG045E		Burlete cuña chico	EPDM
AG060E		Burlete doble contacto exterior	EPDM
AG061E		Burlete doble contacto interior	EPDM
AG062E		Burlete exterior de vidrio	EPDM
AG063E		Burlete interior de vidrio	EPDM
AG065E		Solapa o lengüeta de mosquitero	EPDM
AG066E		Cuerda de mosquitero 5 mm.	PVC



**Guarniciones**

# ROTONDA 640

Ventana corrediza 2 hojas corte a 45°

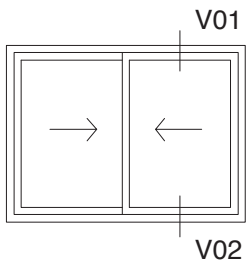

ADR 63

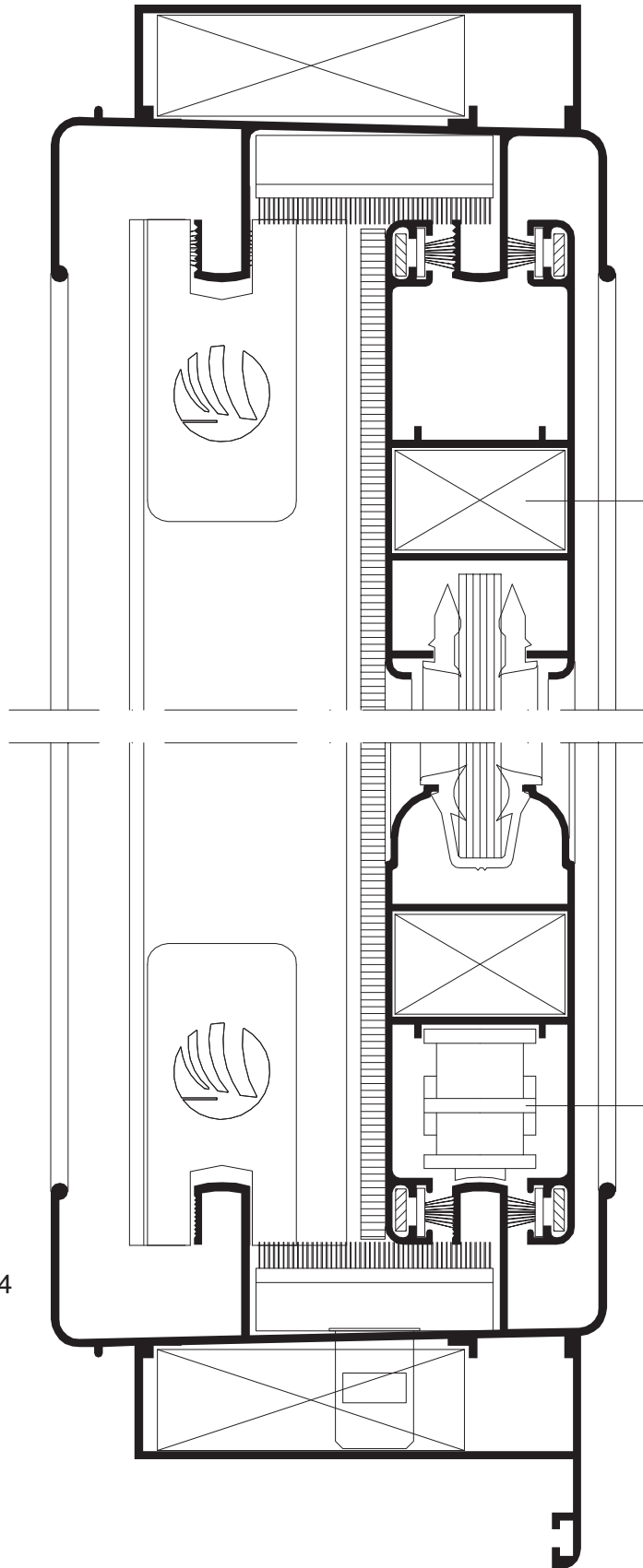

Secciones (Escala 1:1)

# ROTONDA 640

Ventana corrediza 2 hojas corte a 90°

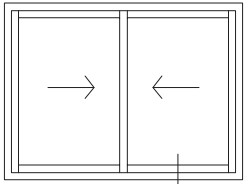

V03

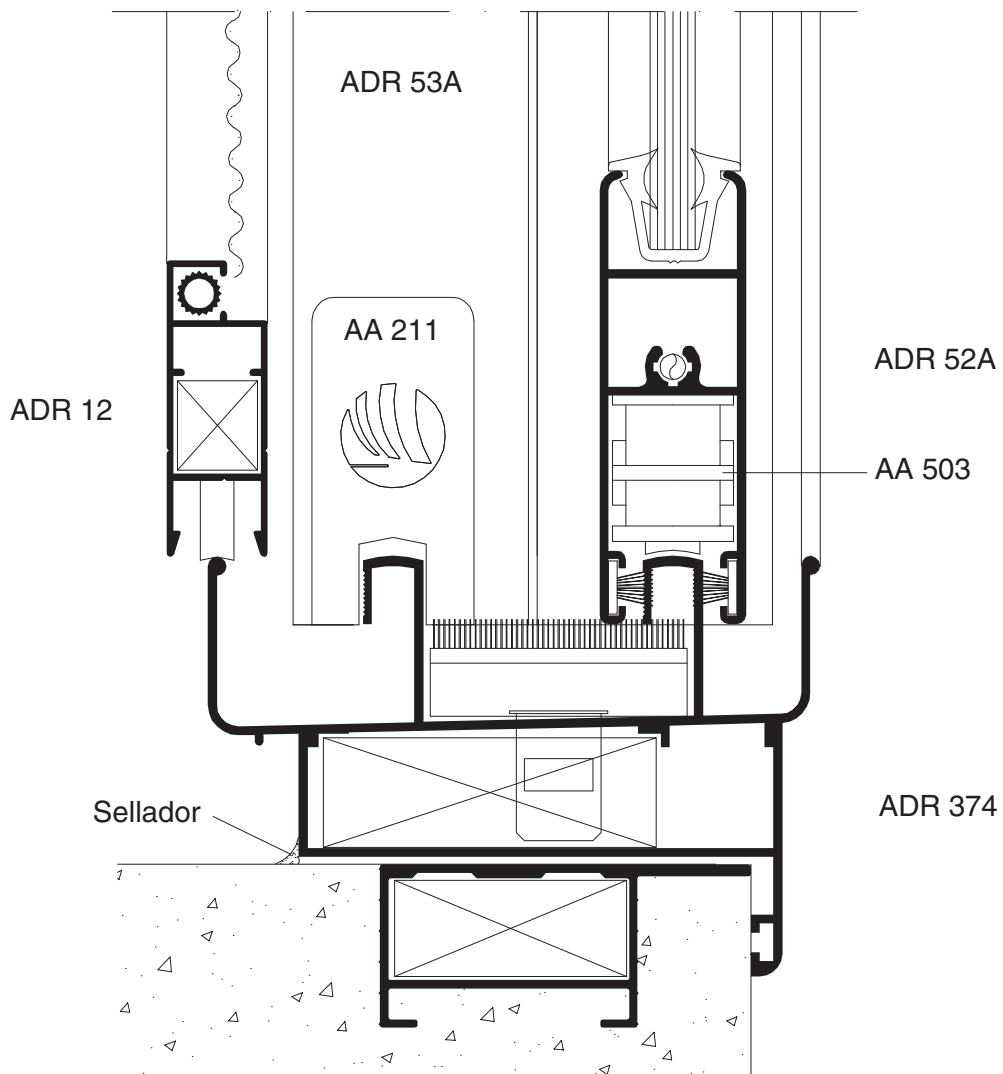

Secciones (Escala 1:1)

# ROTONDA 640

Ventana corrediza 2 hojas corte a 90°  
Opciones encuentro central

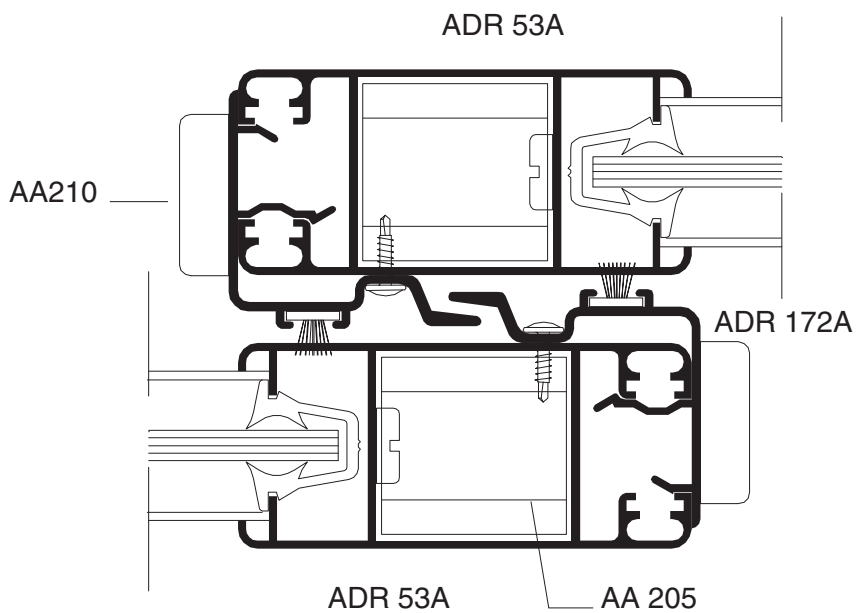
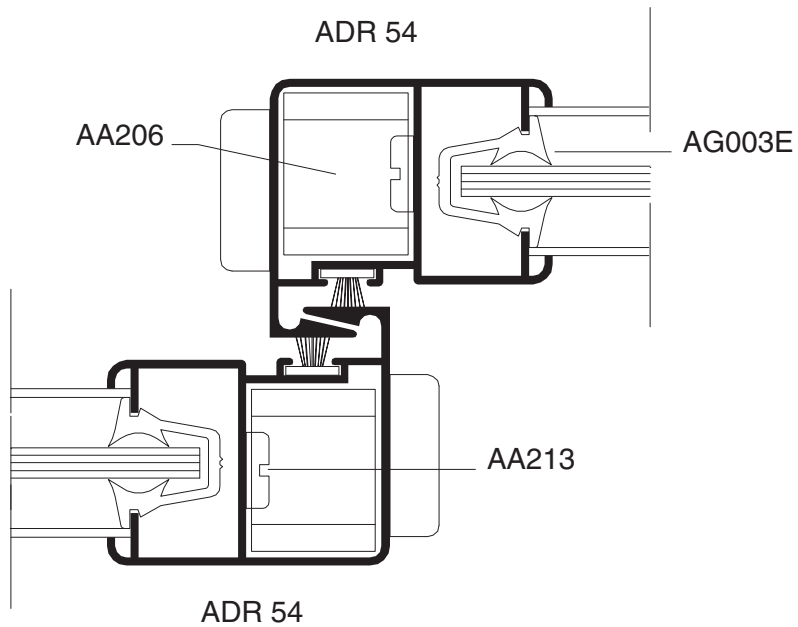
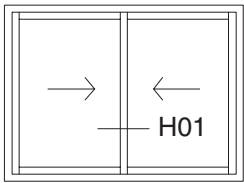

Secciones (Escala 1:1)

# ROTONDA 640

Ventana corrediza 2 hojas corte a 45°  
Opciones encuentro central

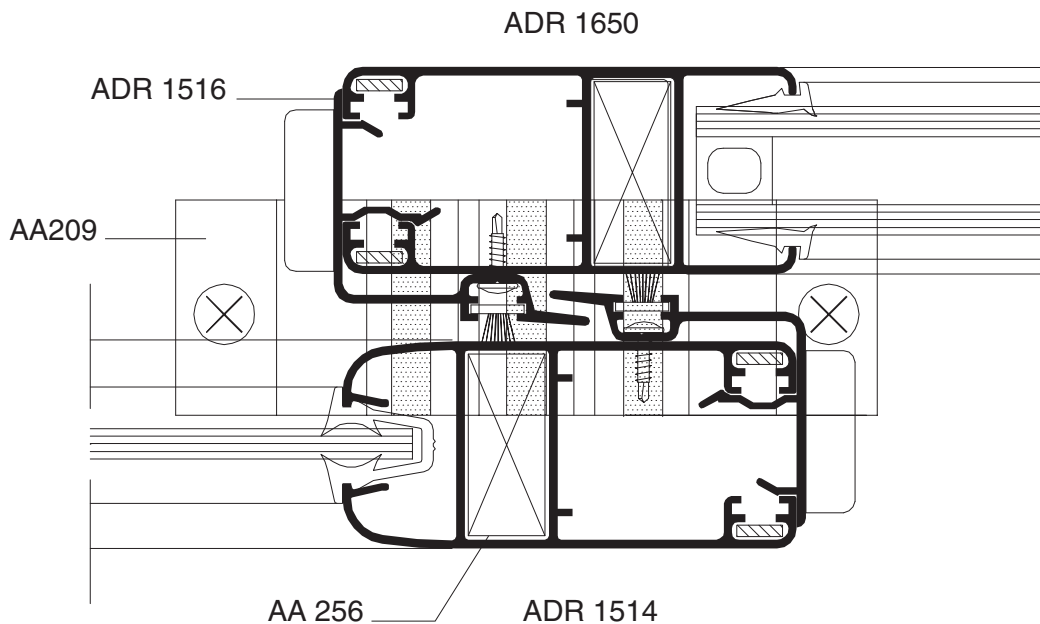
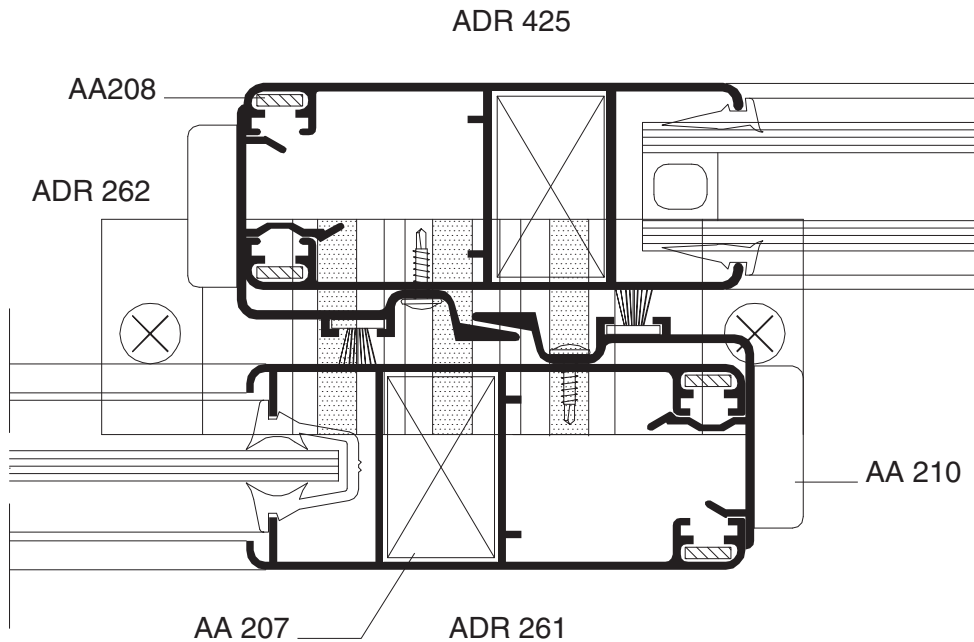
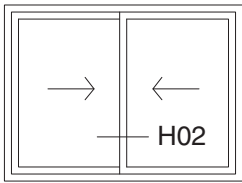

Secciones (Escala 1:1)

# ROTONDA 640

Ventana corrediza 2 hojas corte a 45°  
Aplicación refuerzos de parantes centrales

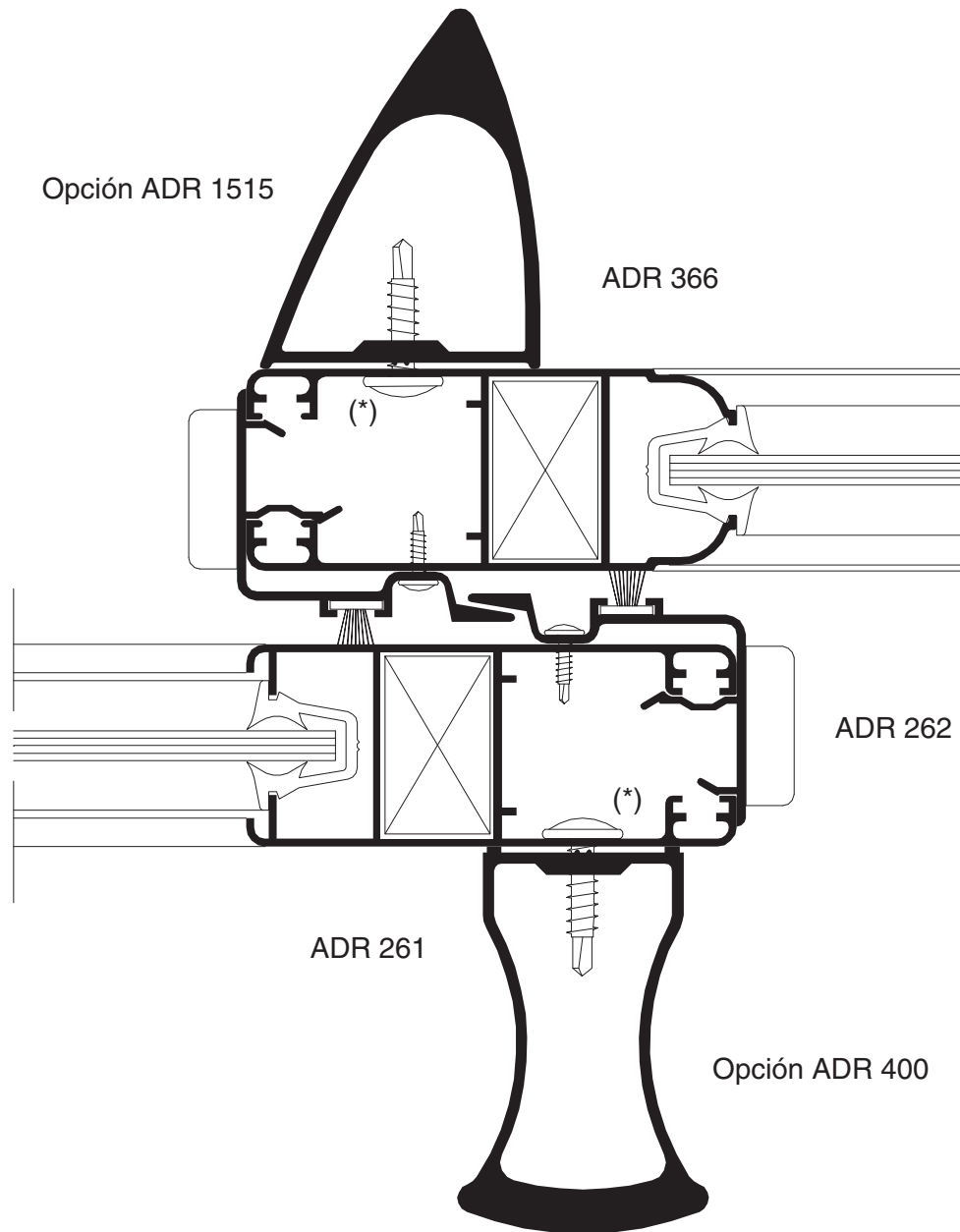
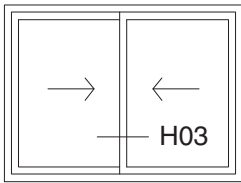

(\*) Colocar un tornillo cada 250 mm. mínimo



Secciones (Escala 1:1)

# ROTONDA 640

Ventana corrediza 2 hojas + Paño fijo corte a 45°

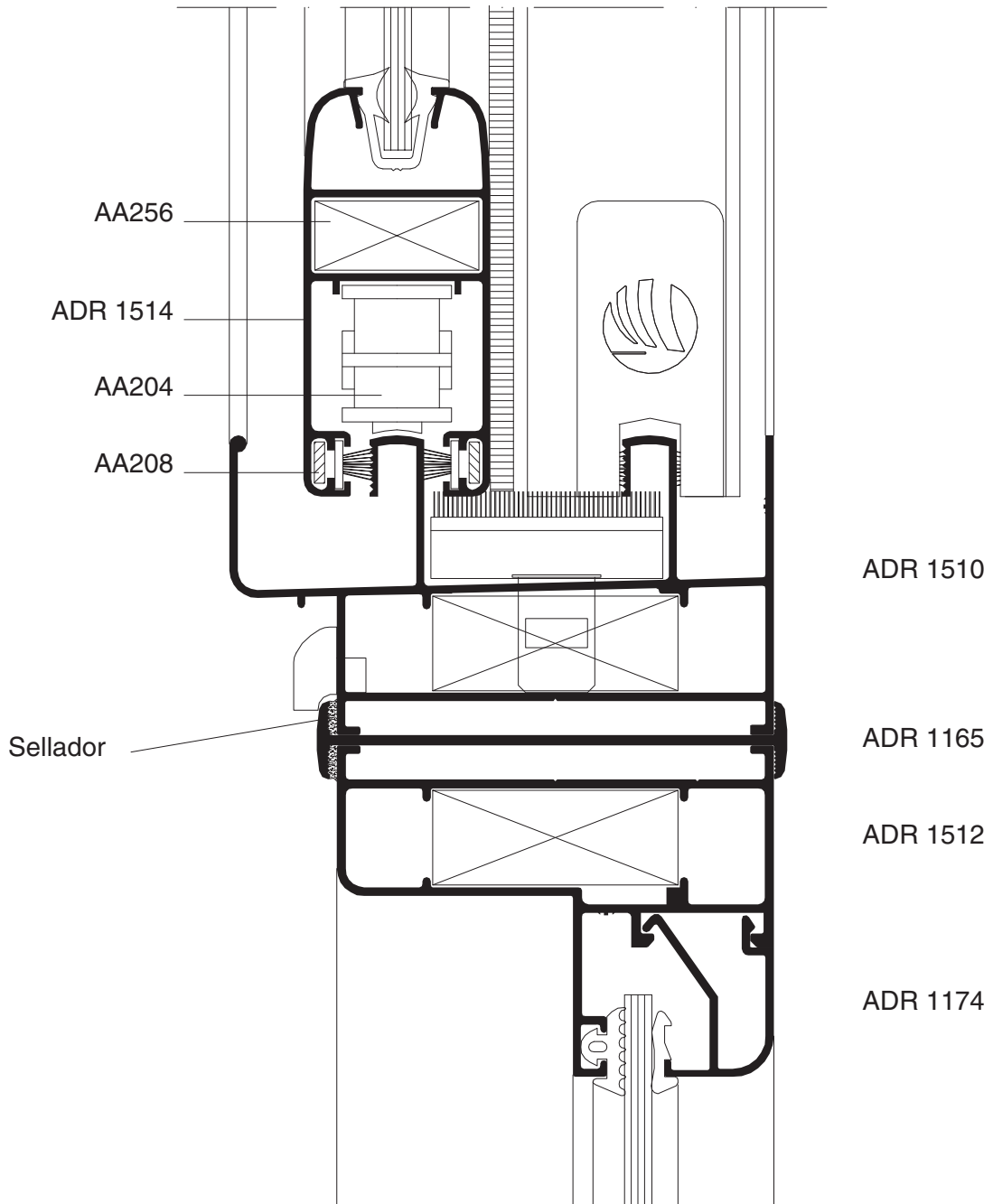
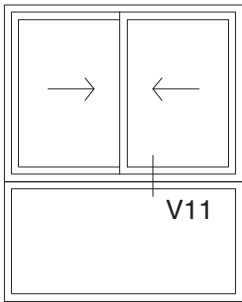

Secciones (Escala 1:1)

# ROTONDA 640

Ventana corrediza 2 hojas corte a 45°

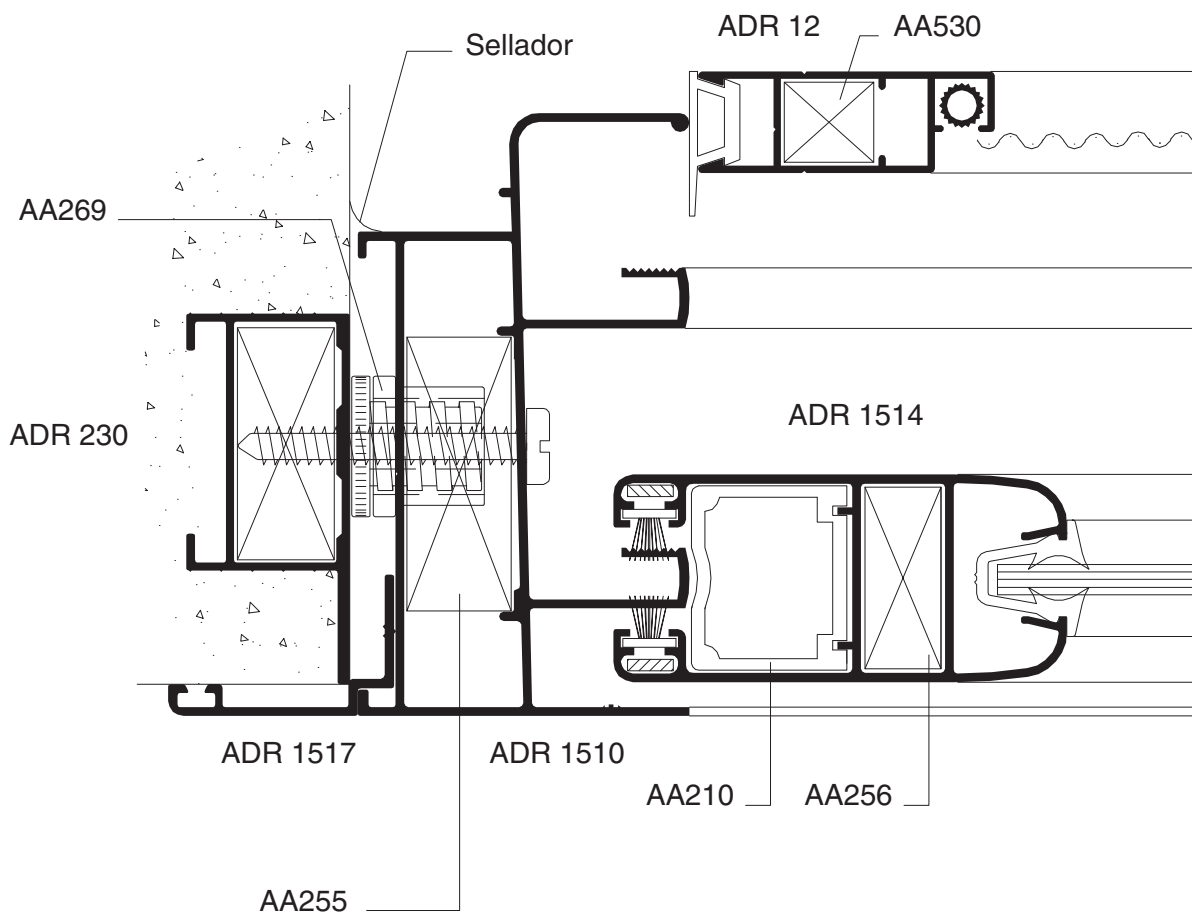
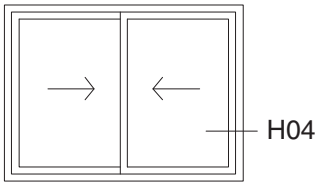

Secciones (Escala 1:1)

# ROTONDA 640

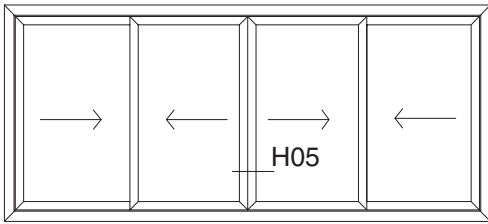

Ventana corrediza 4 hojas  
Encuentro central

Opción corte a 90°

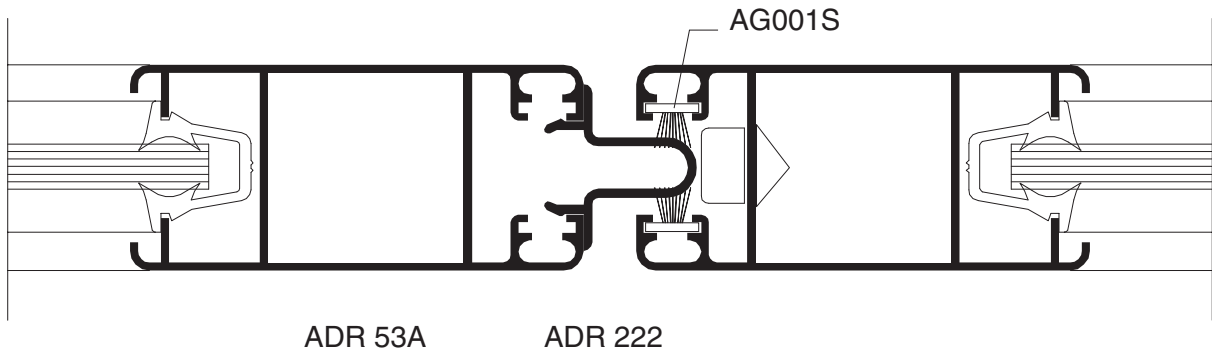

Opción corte a 45°

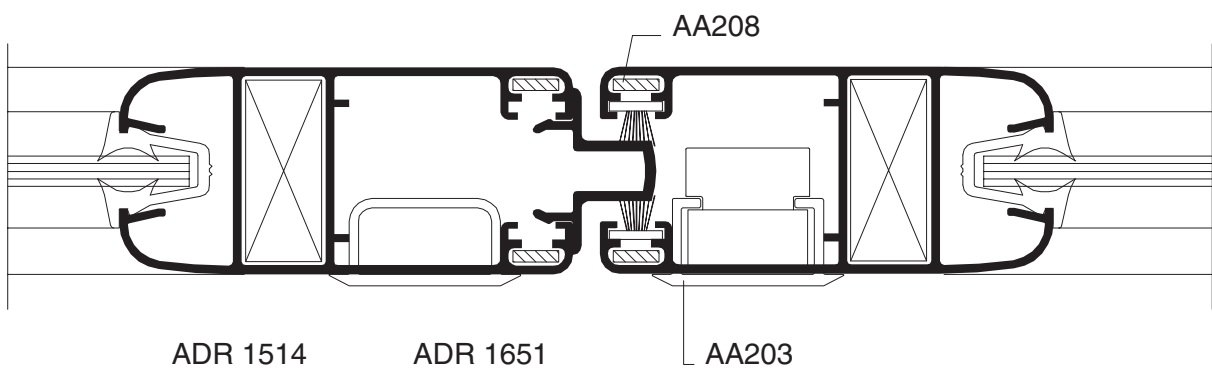

Nota: Válido para 3 hojas, con 2 en una misma guía.



Secciones (Escala 1:1)

# ROTONDA 640

Paño fijo

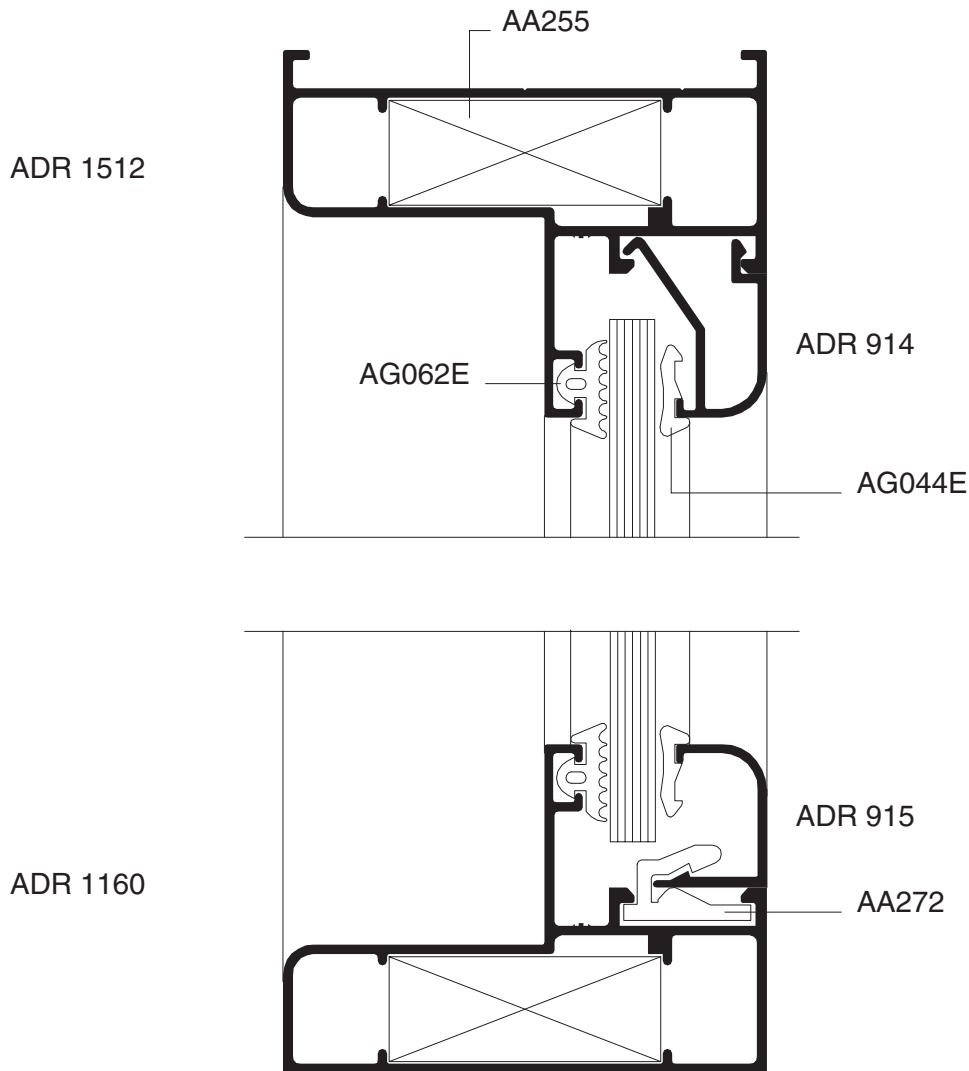
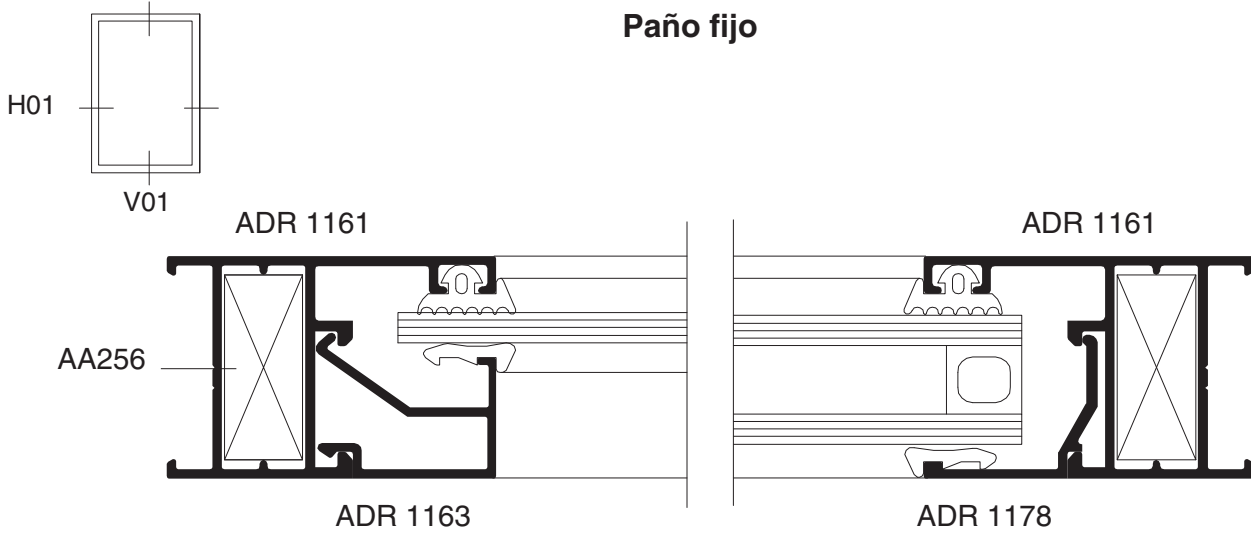

Secciones (Escala 1:1)

# ROTONDA 640

Ventana de abrir

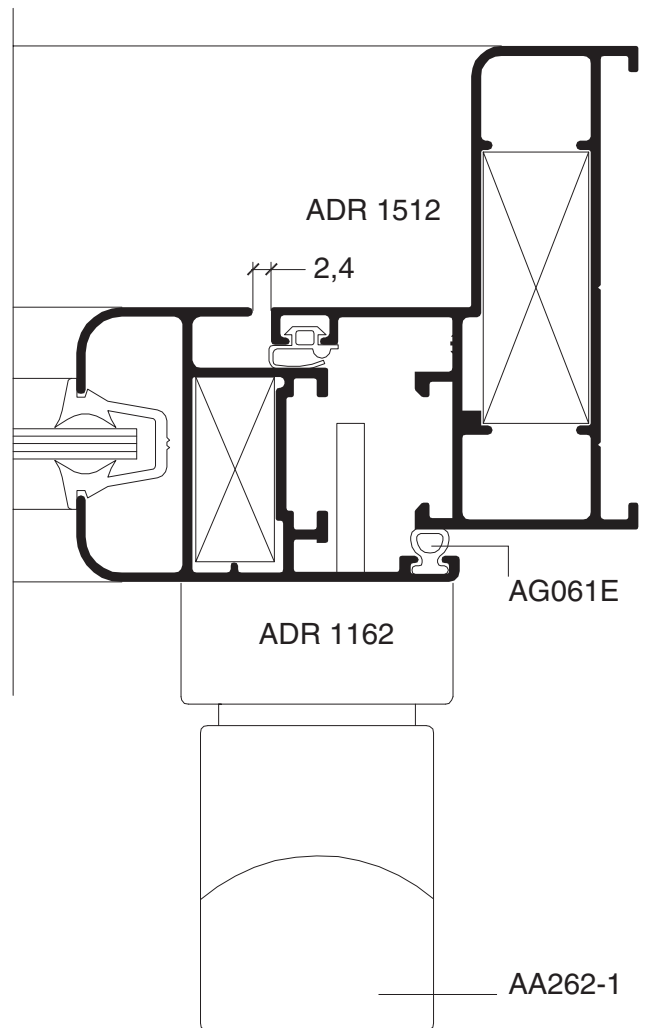
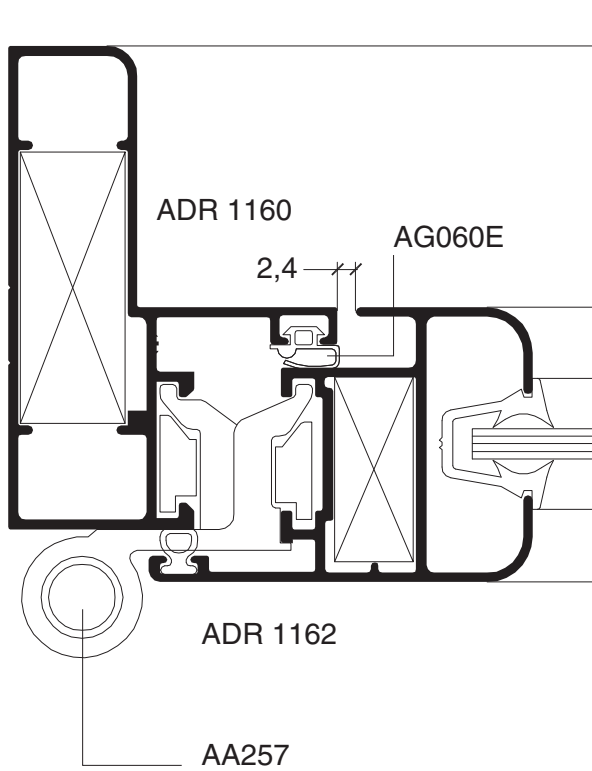
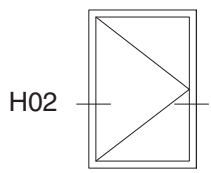

Secciones (Escala 1:1)

# ROTONDA 640

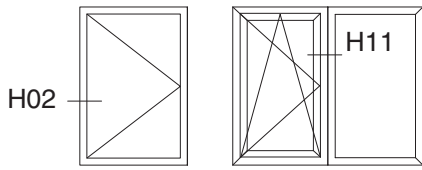

Ventana de abrir  
Ventana de abrir + paño fijo

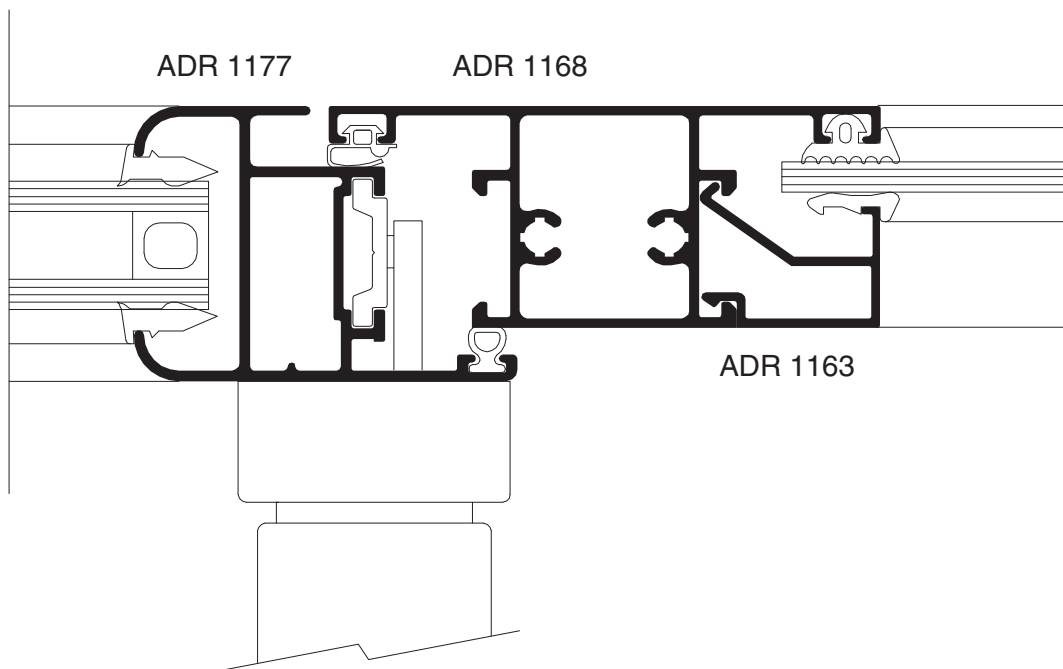
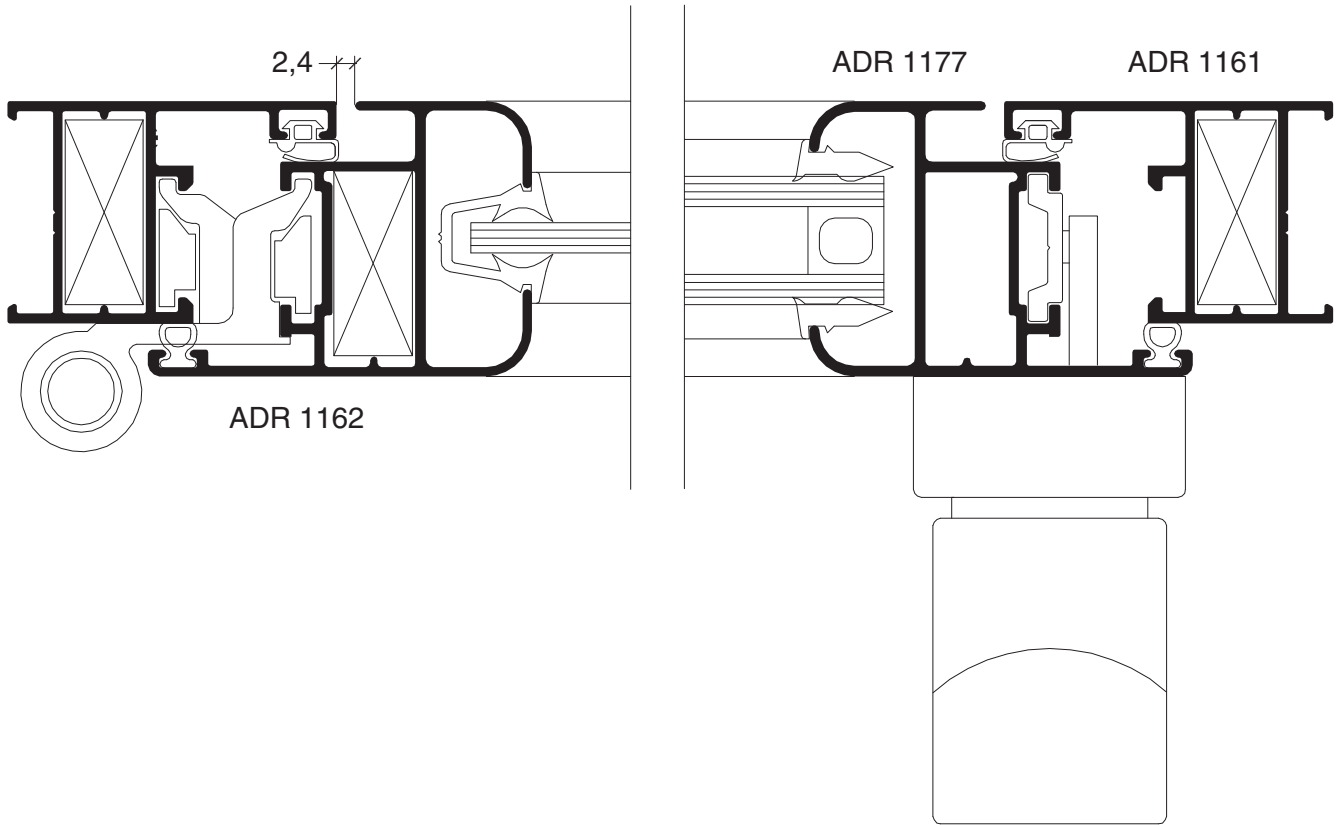

Secciones (Escala 1:1)

# ROTONDA 640

Ventana de abrir de 2 y 3 hojas

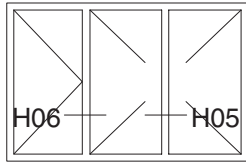
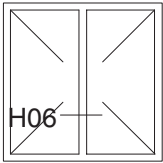

H06

ADR 1162

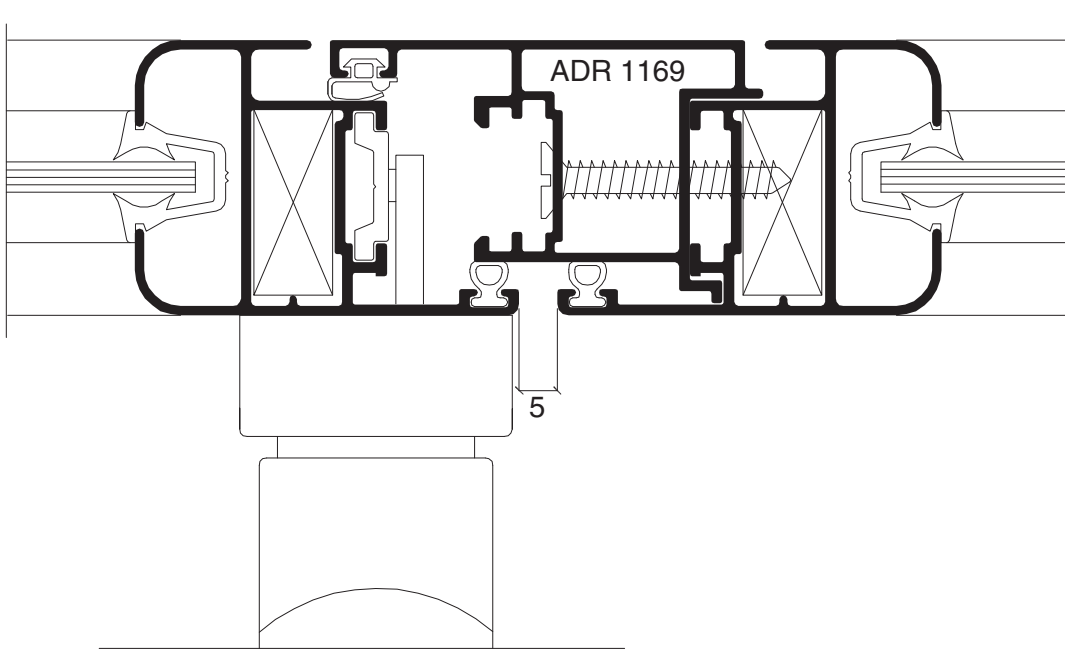

H05

ADR 1162

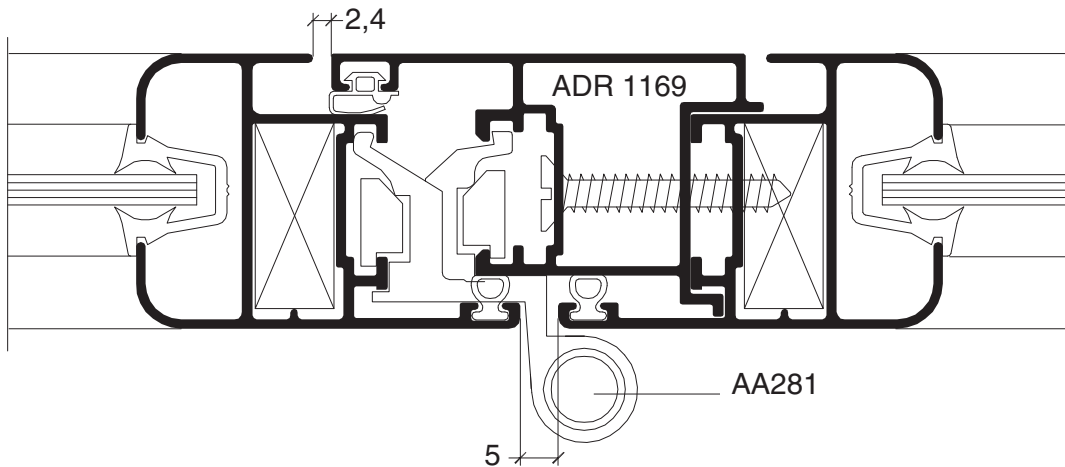

Secciones (Escala 1:1)

# ROTONDA 640

## Ventana Banderola

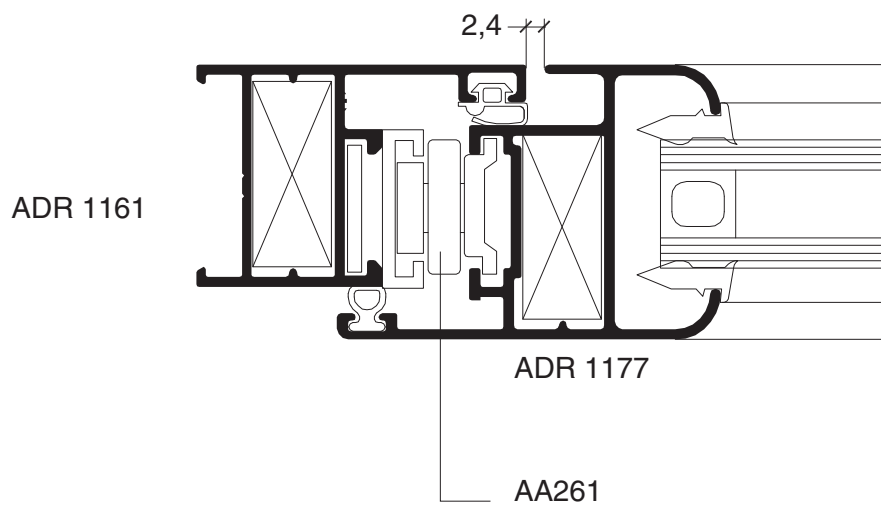
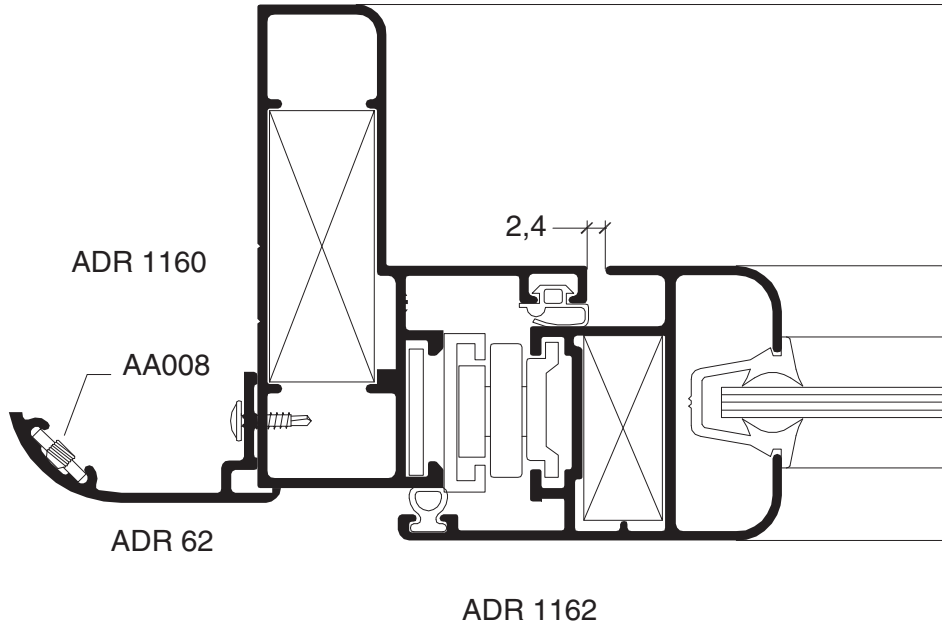
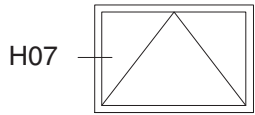

**Secciones (Escala 1:1)**

# ROTONDA 640

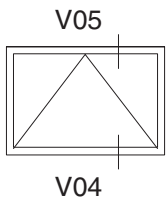

## Ventana Banderola

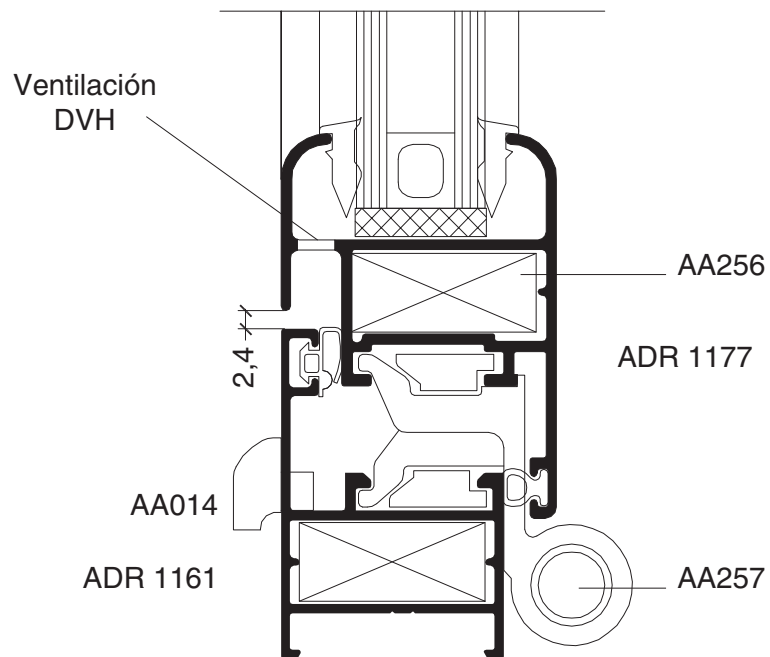
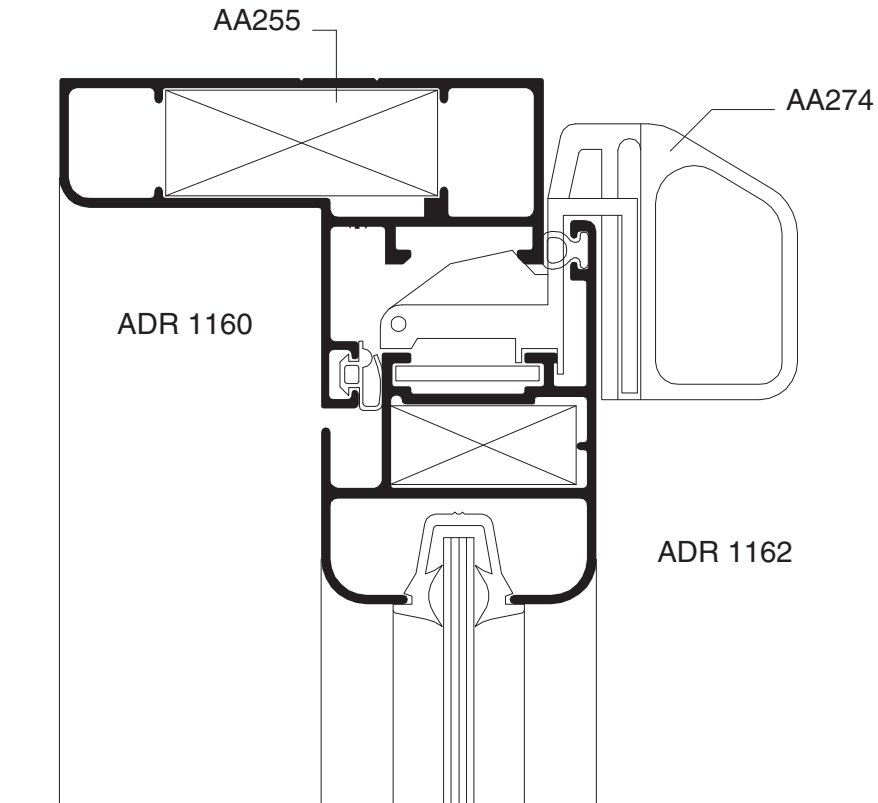

## Secciones (Escala 1:1)

# ROTONDA 640

## Ventana Desplazable

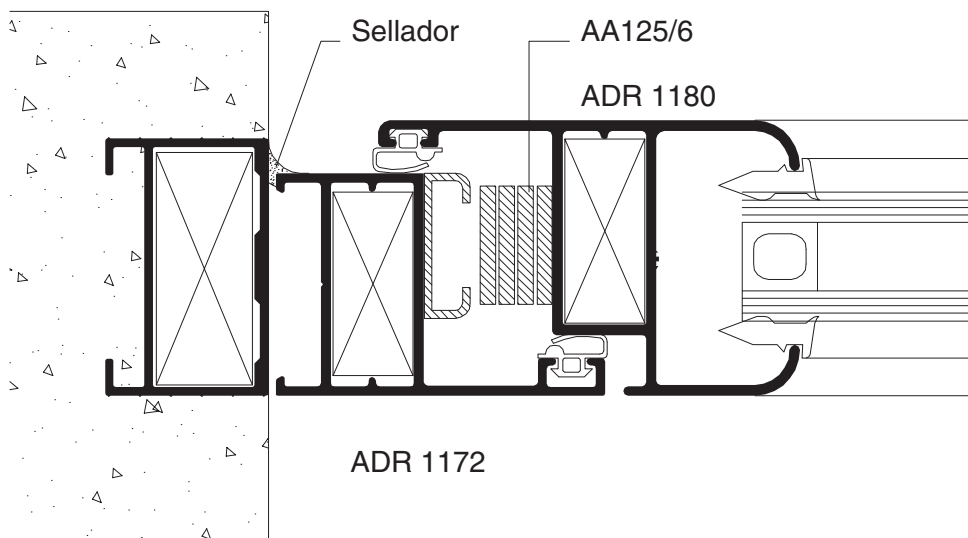
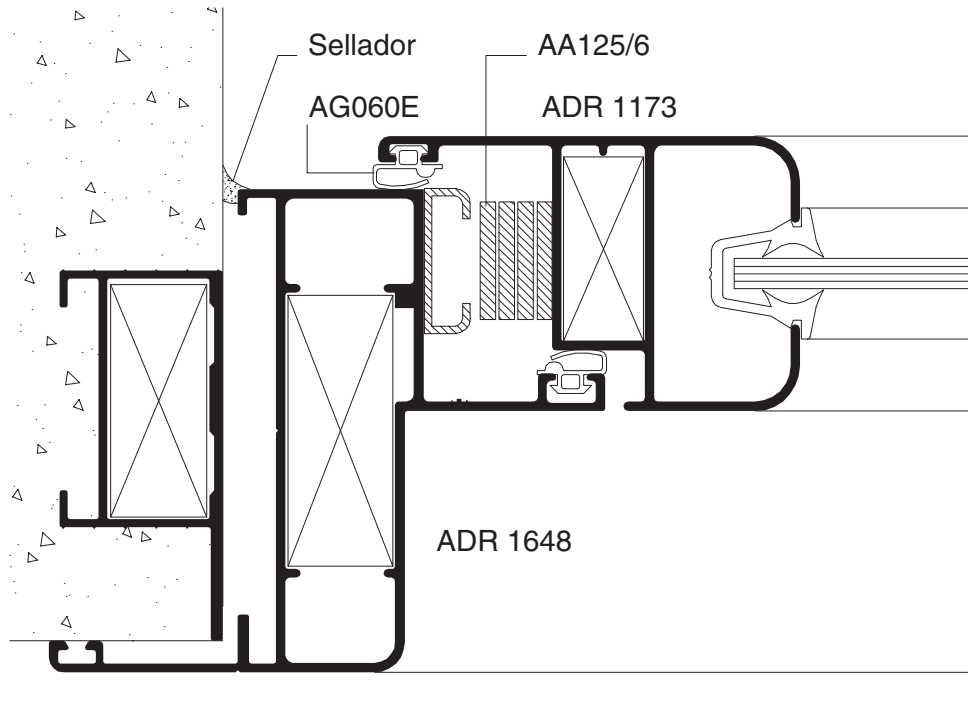
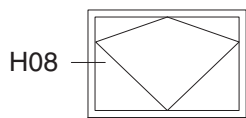

Secciones (Escala 1:1)

# ROTONDA 640

## Ventana Desplazable

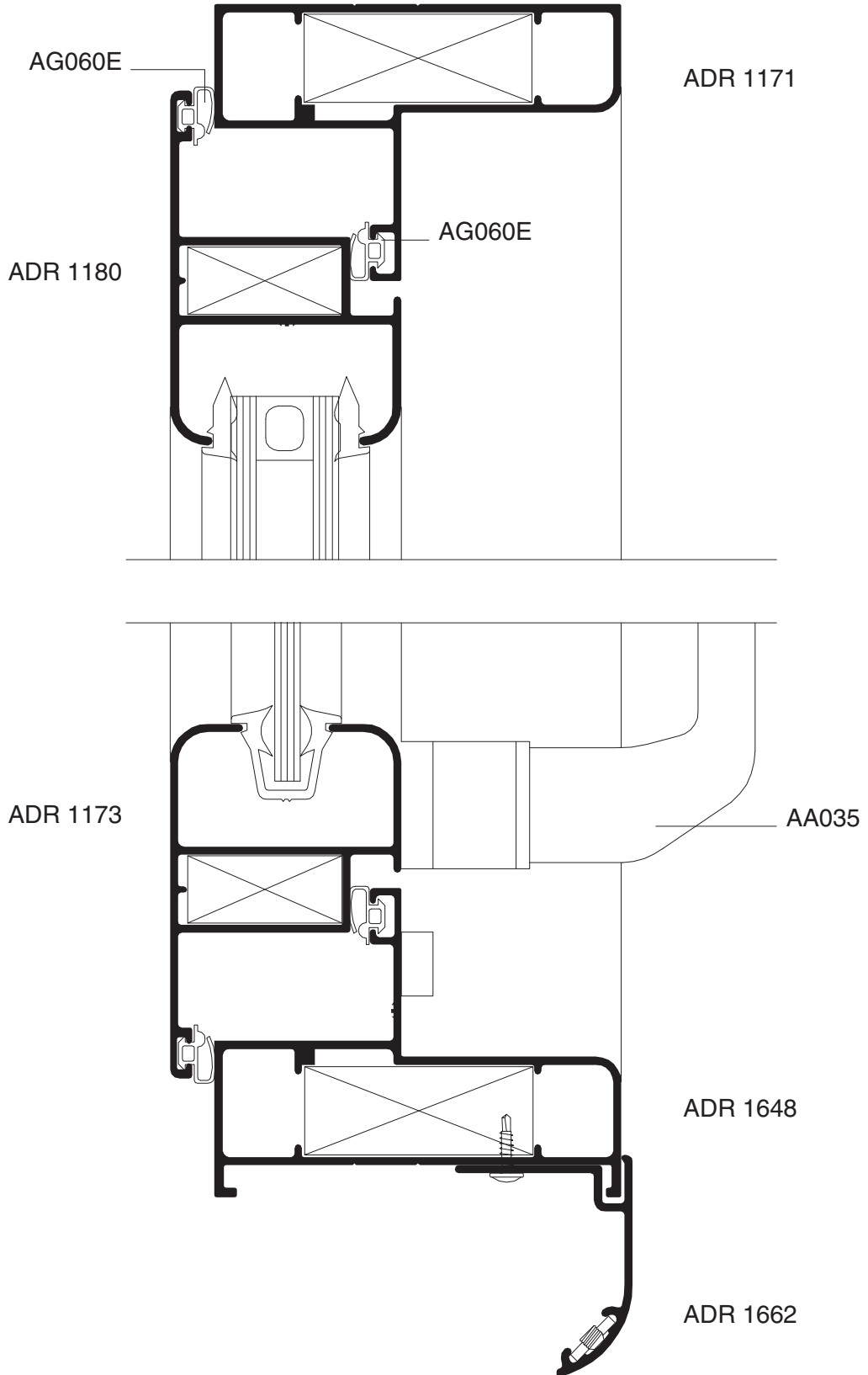
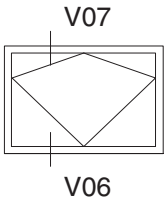

Secciones (Escala 1:1)

# ROTONDA 640

Puerta de abrir de dos hojas

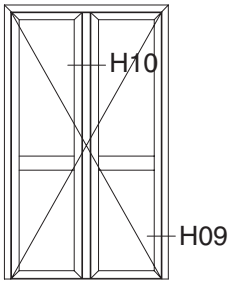

H09

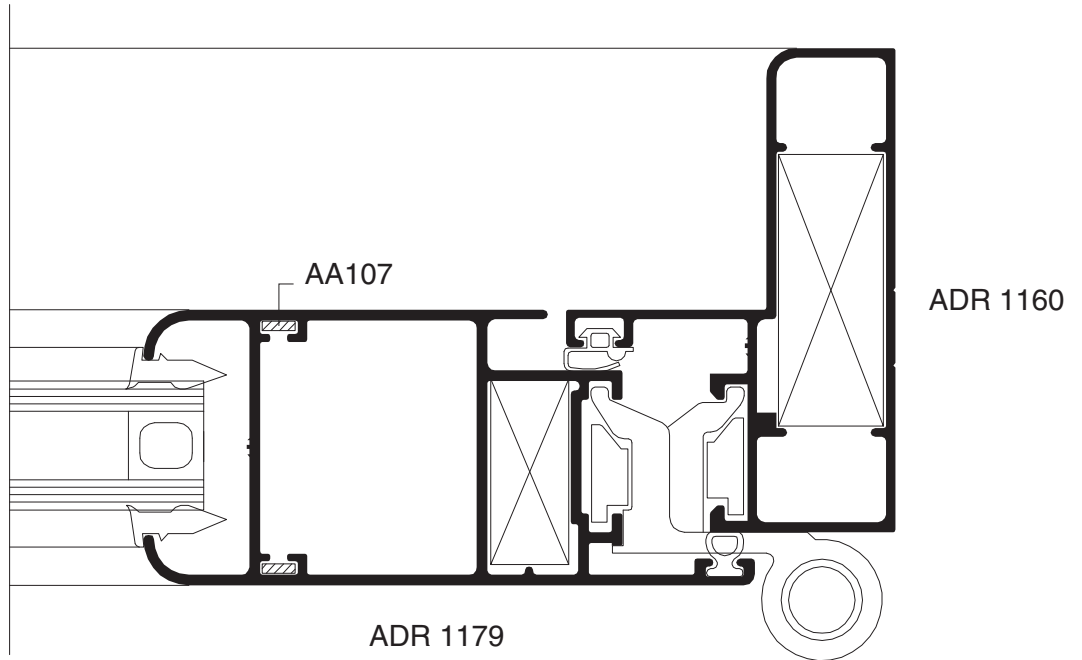

H10

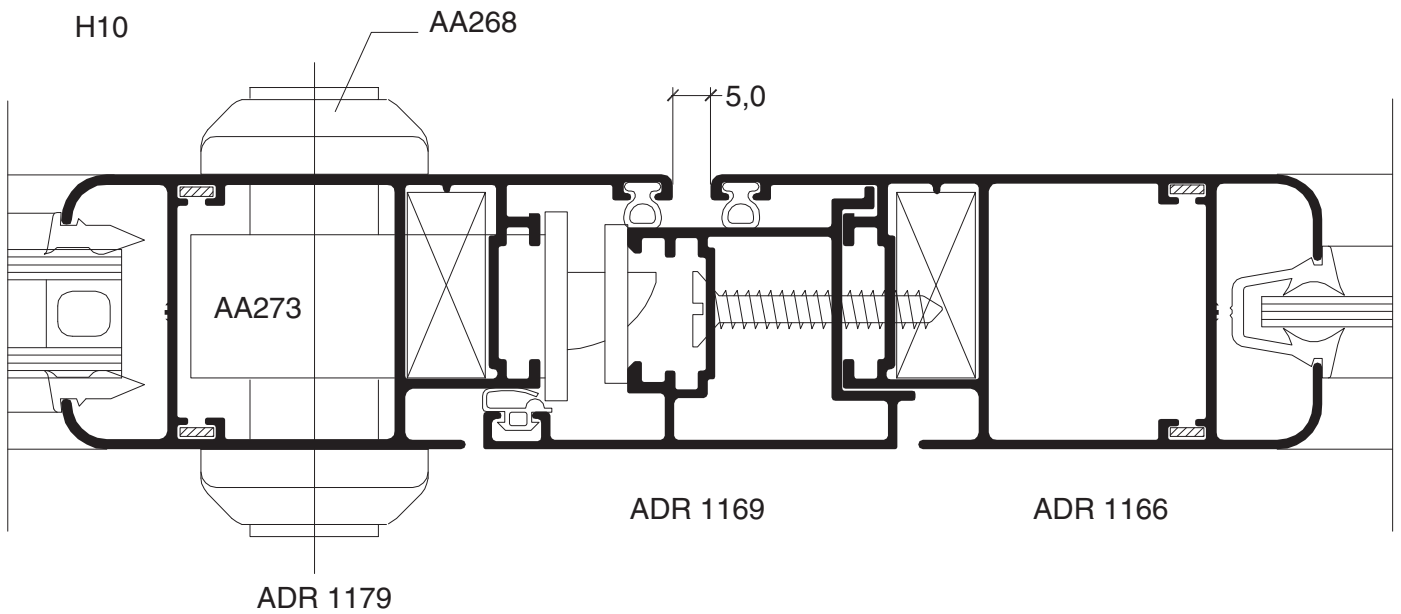

Secciones (Escala 1:1)

# ROTONDA 640

Puerta de abrir de dos hojas

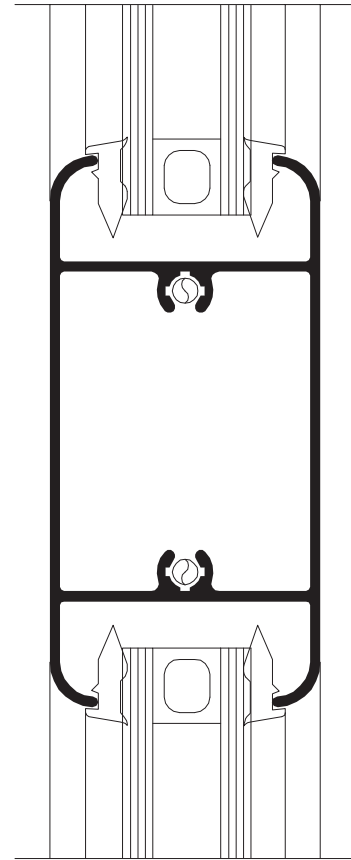
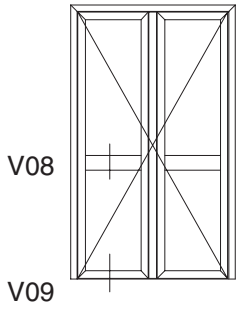

V09

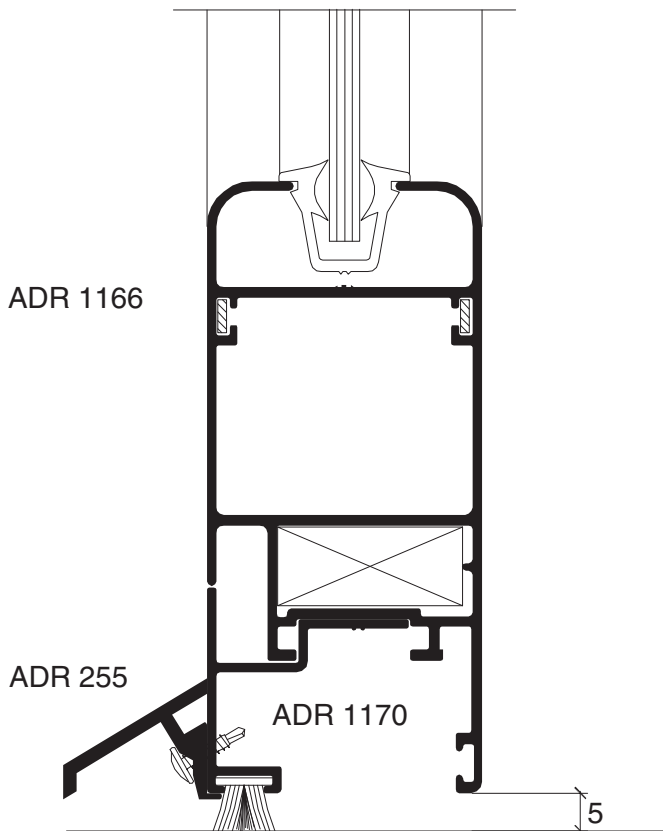

Secciones (Escala 1:1)

# ROTONDA 640

Límites de utilización estática  
para  $J = 3,1 \text{ cm}^4$

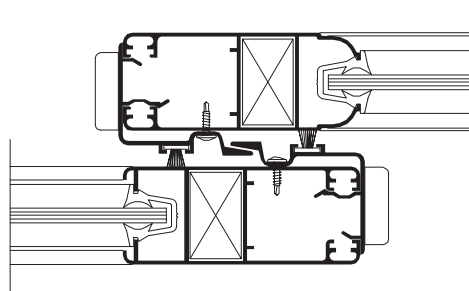
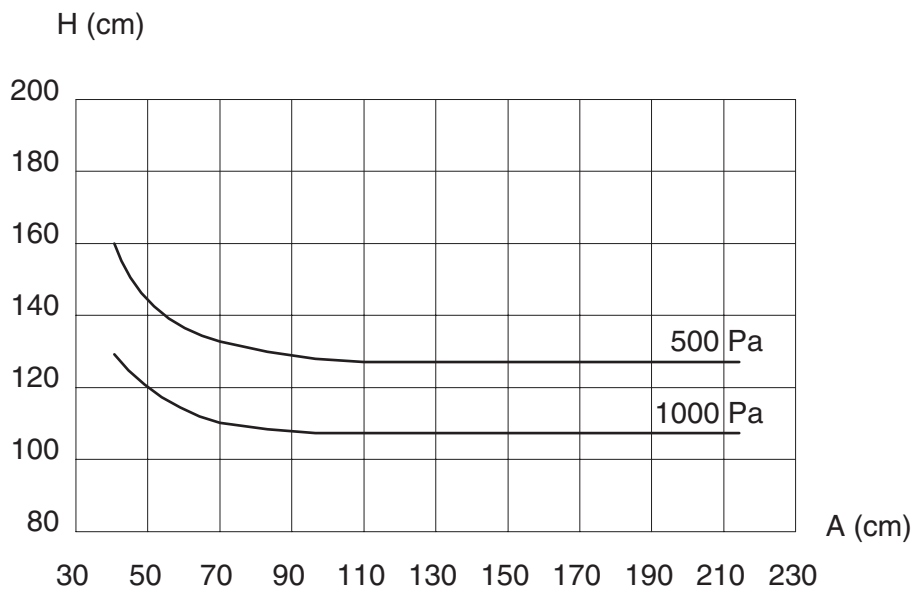
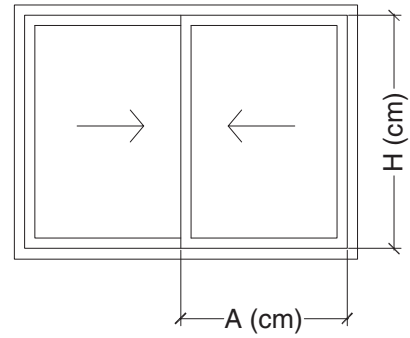

Límites de utilización estática

# ROTONDA 640

Límites de utilización estática  
para  $J = 9,8 \text{ cm}^4$

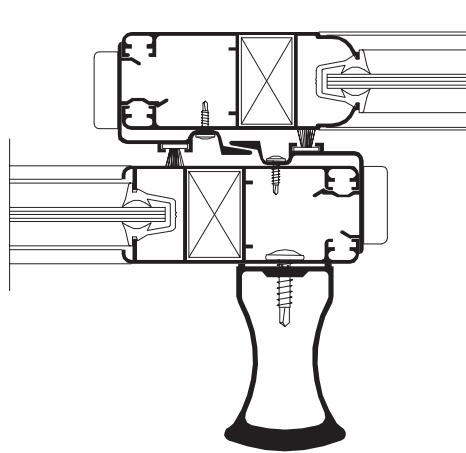
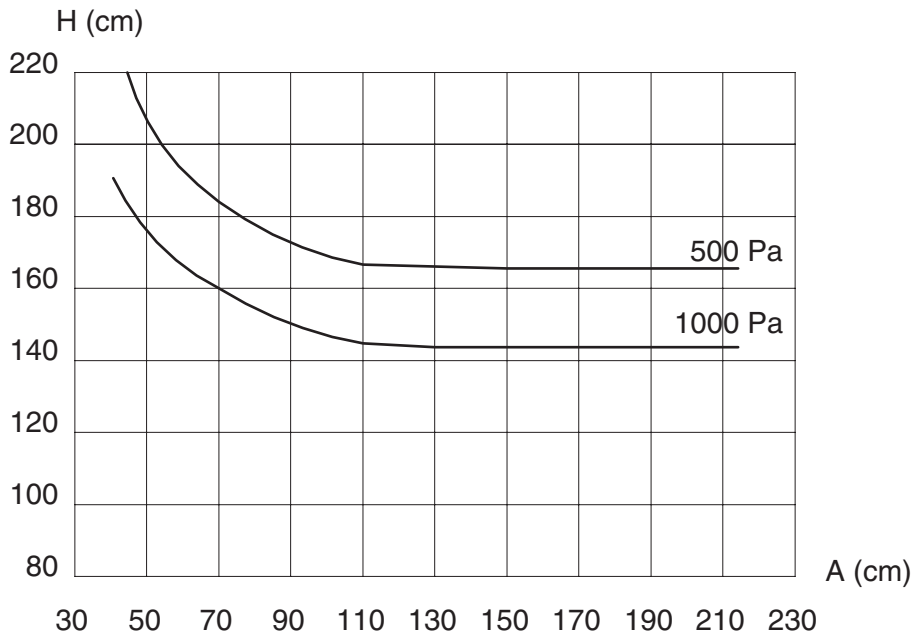
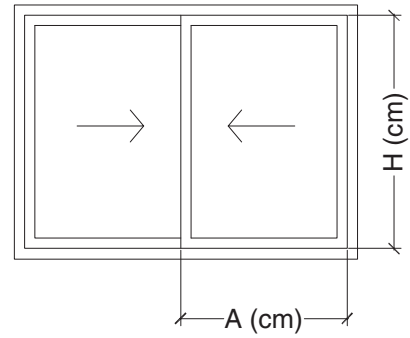

Límites de utilización estática

# ROTONDA 640

Límites de utilización estática  
para  $J = 16,6 \text{ cm}^4$

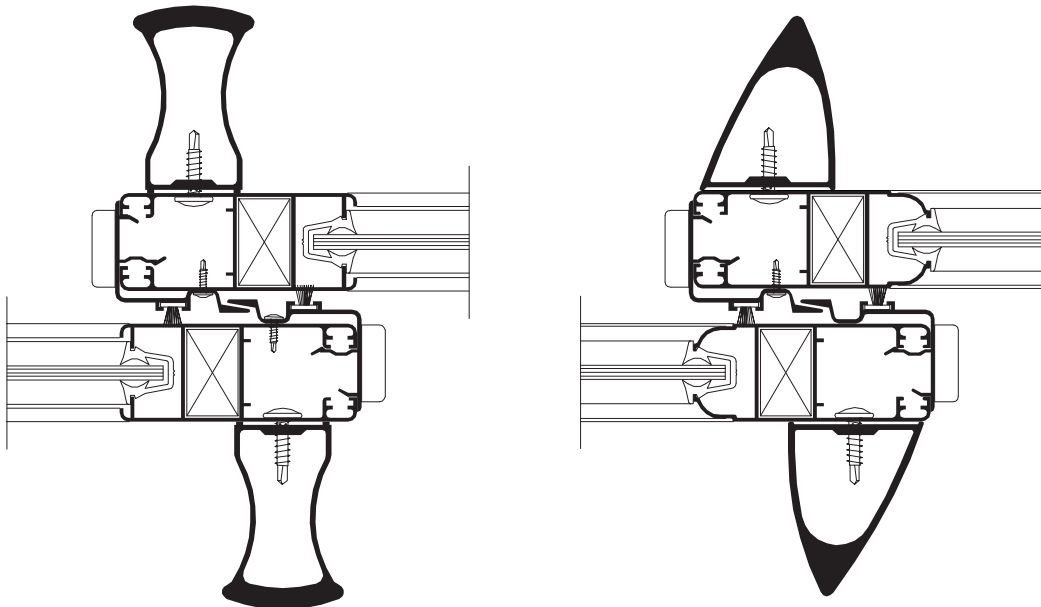
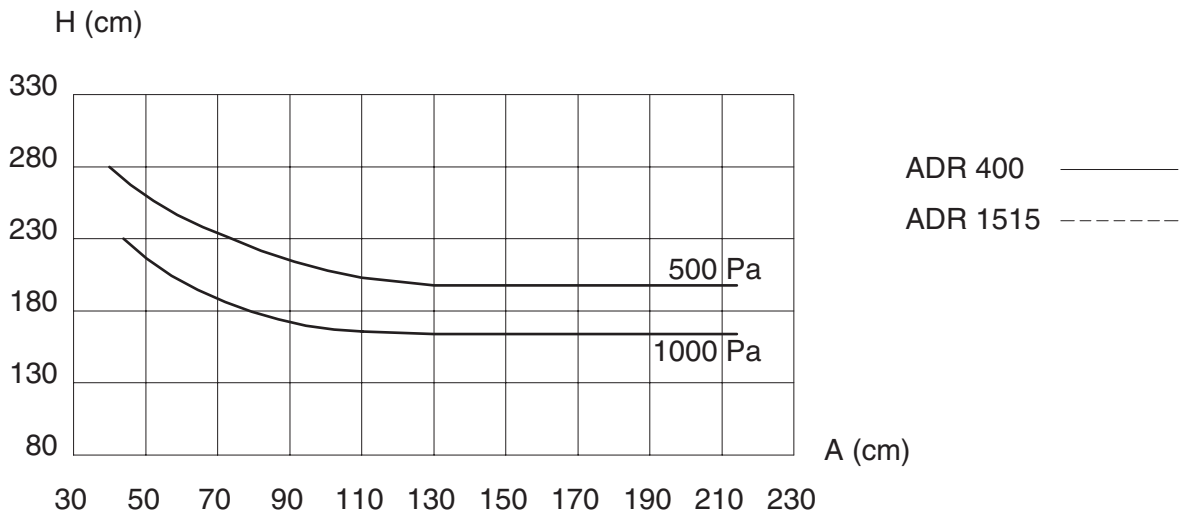
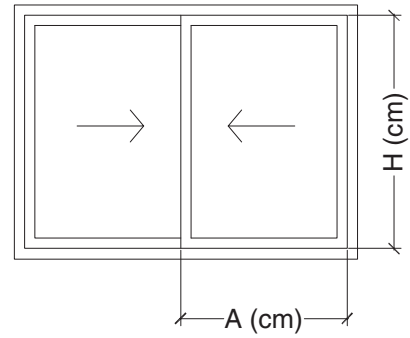

Límites de utilización estática

# ROTONDA 640

Ventana corrediza 2 hojas corte a 45°

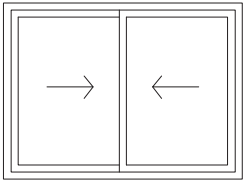

## Perfiles

Código	Descripción	Cant.	Medida	Corte
ADR 374	Marco	2	A	45°/45°
ADR 374	Marco	2	H	45°/45°
ADR 261	Hoja vidrio simple	4	$(A + 4)/2$	45°/45°
ADR 261	Hoja vidrio simple	4	$H - 97$	45°/45°
ADR 262	Cierre de enclapar	2	$H - 97$	90°/90°
ADR 230	Premarco	2	$H + 23$	45°/45°
ADR 230	Premarco	2	$A + 23$	45°/45°

## Accesorios

Código	Descripción	Cant.
AA201	Escuadro de tracción	4
AA202	Pieza hoja guía	4
AA203	Cierre lateral	2
AA204	Rueda	4
AA207	Escuadra de tracción hoja	8
AA208	Escuadra alineación hoja	16
AA209	Cortavientos	2
AA210	Tope de hoja	2
AA211	Tapa parante corrediza	4
AA212	Tapón caja de agua	2
AA214	Boca de desagüe caja de agua	2
AG001S	Felpa 7 x 6 con fin seal	$6H + 4A$
AG003E	Burlete universal medio	$4H + 2A$

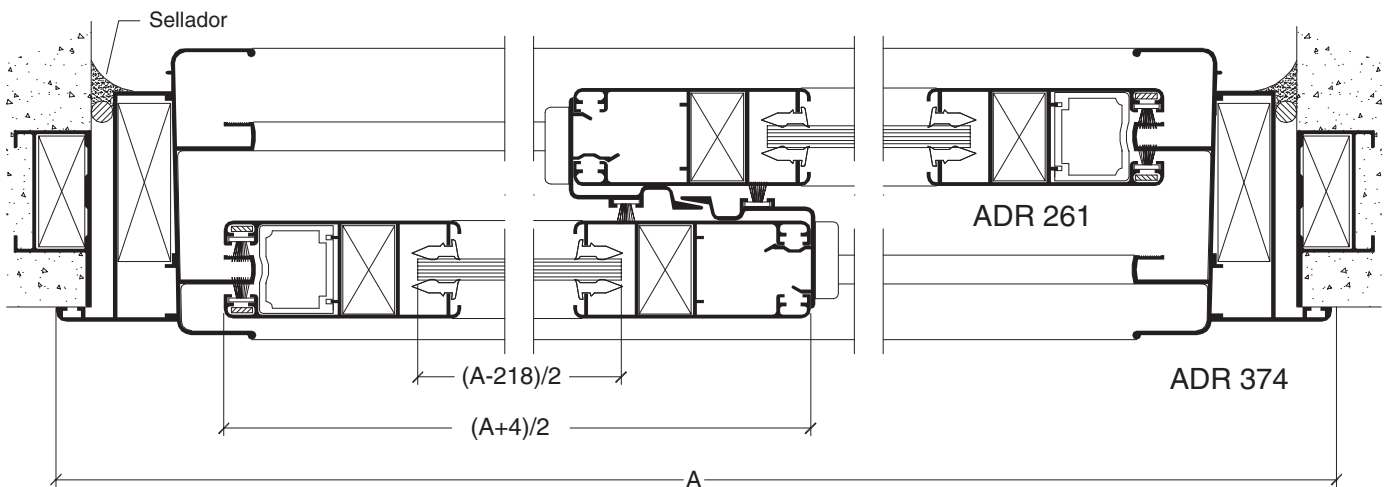
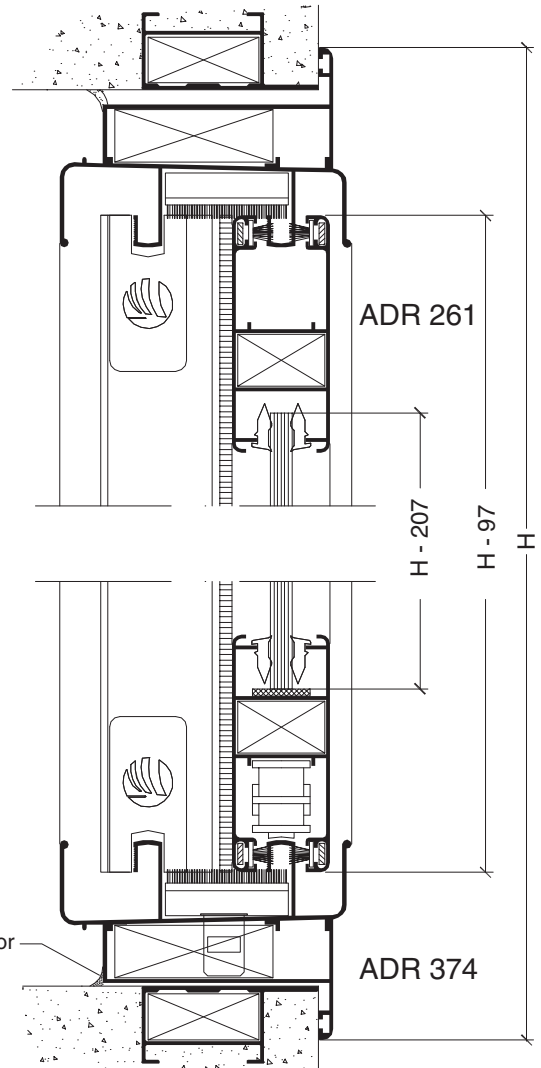

## Medidas de corte

# ROTONDA 640

Ventana corrediza 2 hojas corte a 45°  
con refuerzos centrales

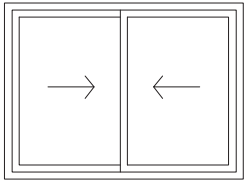

## Perfiles

Código	Descripción	Cant.	Medida	Corte
ADR 1510	Marco	2	A	45°/45°
ADR 1510	Marco	2	H	45°/45°
ADR 1514	Hoja vidrio simple	4	$(A - 8)/2$	45°/45°
ADR 1514	Hoja vidrio simple	4	H - 68	45°/45°
ADR 1516	Cierre de enclapar	2	H - 68	90°/90°
ADR 1515	Refuerzo parante central	2	H - 118	90°/90°
ADR 1517	Tapajuntas	2	A + 50	45°/45°
ADR 1517	Tapajuntas	2	H + 50	45°/45°
ADR 230	Premarco	2	A + 45	45°/45°
ADR 230	Premarco	2	H + 45	45°/45°

## Accesorios

Código	Descripción	Cant.
AA202	Pieza hoja guía	4
AA203	Cierre lateral	2
AA204	Rueda	4
AA208	Escuadra alineación hoja	16
AA209	Cortavientos	2
AA210	Tope de hoja	2
AA211	Tapa parante corrediza	4
AA226	Tapón caja de agua	2
AA214	Boca de desagüe caja de agua	2
AA255	Escuadra de tracción marco	4
AA256	Escuadra de tracción hoja	4
AG001S	Felpa 7 x 6 con fin seal	6H + 4A
AG003E	Burlete universal medio	4H + 2A

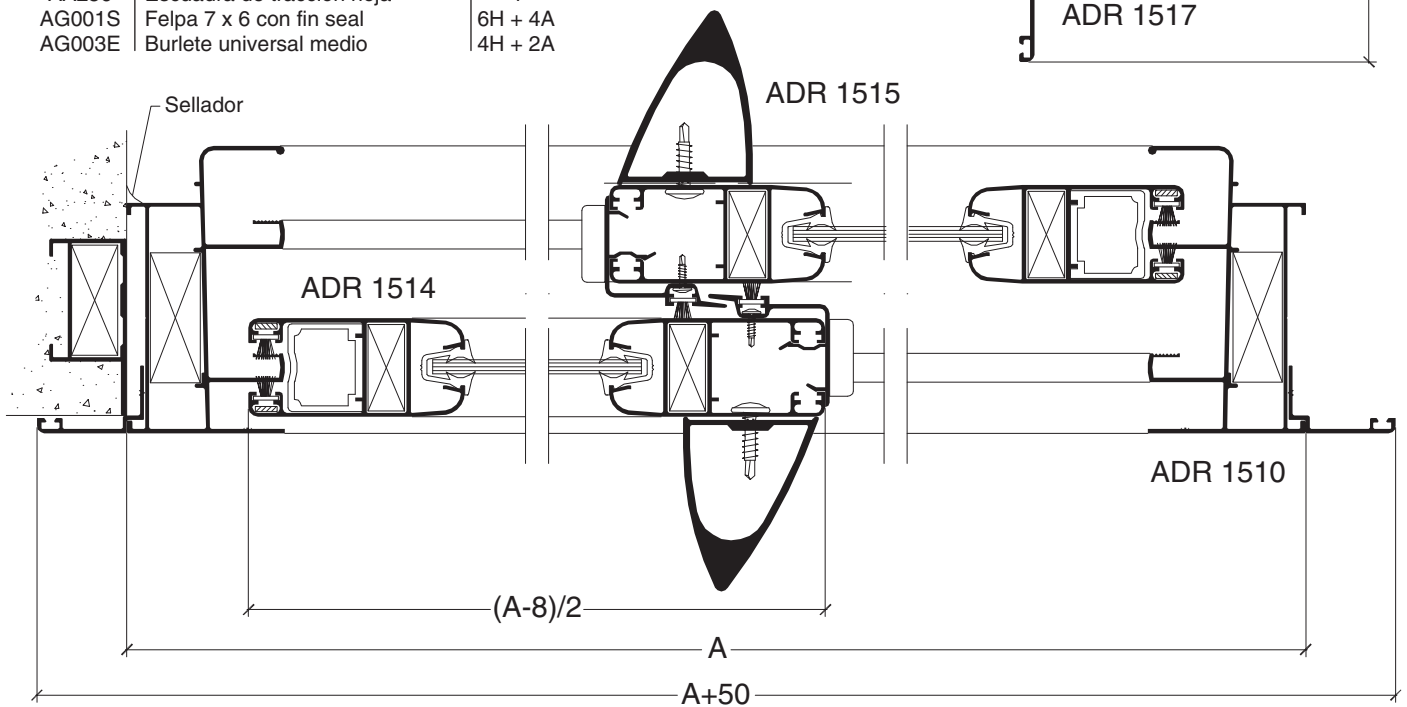
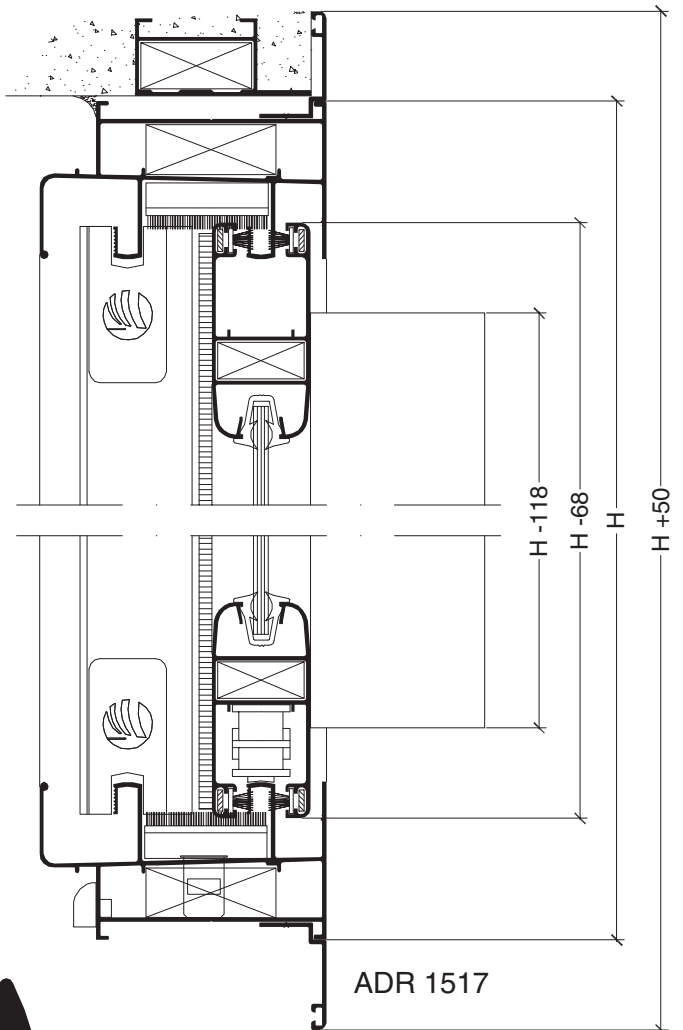

## Medidas de corte

# ROTONDA 640

Ventana corrediza 2 hojas corte a 90°

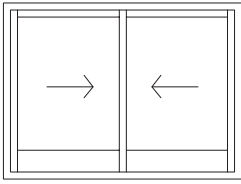

## Perfiles

Código	Descripción	Cant.	Medida	Corte
ADR 63	Marco	2	A	45°/45°
ADR 63	Marco	2	H	45°/45°
ADR 52A	Cabezal de hoja	2	$(A - 227)/2$	90°/90°
ADR 53A	Parante lateral	4	H - 62	90°/90°
ADR 172	Cierre de enclapar	2	H - 62	90°/90°
ADR 292	Zócalo alto	2	$(A - 227)/2$	90°/90°

## Accesorios

Código	Descripción	Cant.
AA201	Escuadra de tracción	4
AA203	Cierre lateral	2
AA205	Tapón parantes	8
AA209	Cortavientos	2
AA210	Tope de hoja	2
AA211	Tapa parante corrediza	4
AA212	Tapón caja de agua	2
AA213	Tornillo de armado	12
AA214	Boca de desagüe de agua	2
AA503	Rueda	4
AG001S	Felpa 7 x 6 con fin seal	6H + 4A
AG003S	Burlete universal medio	4H + 2A

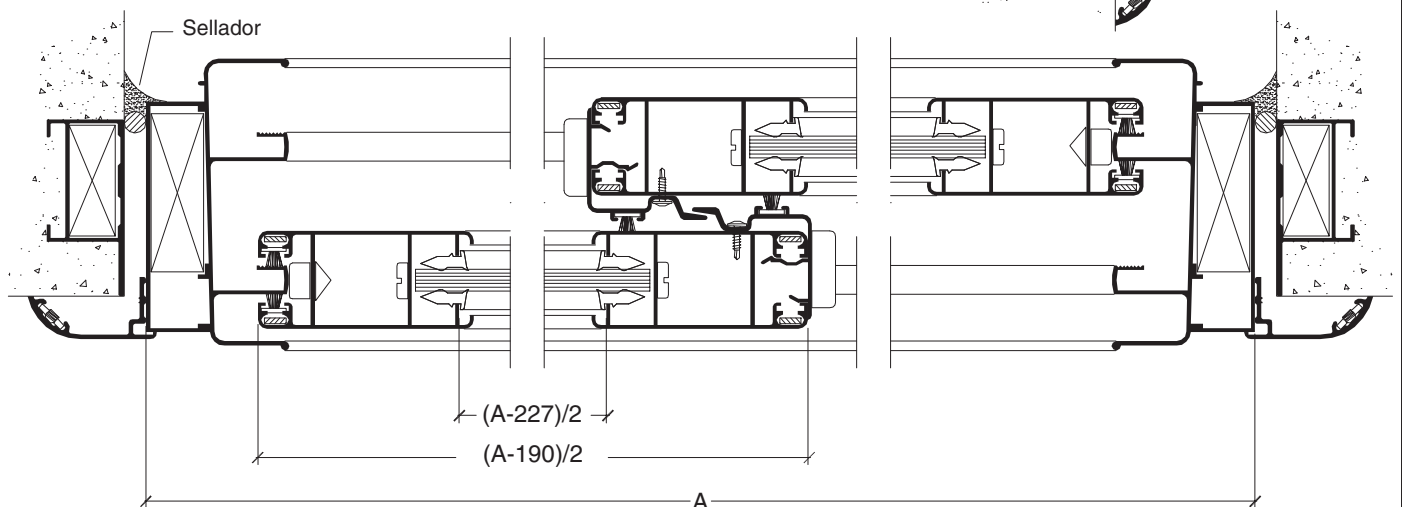
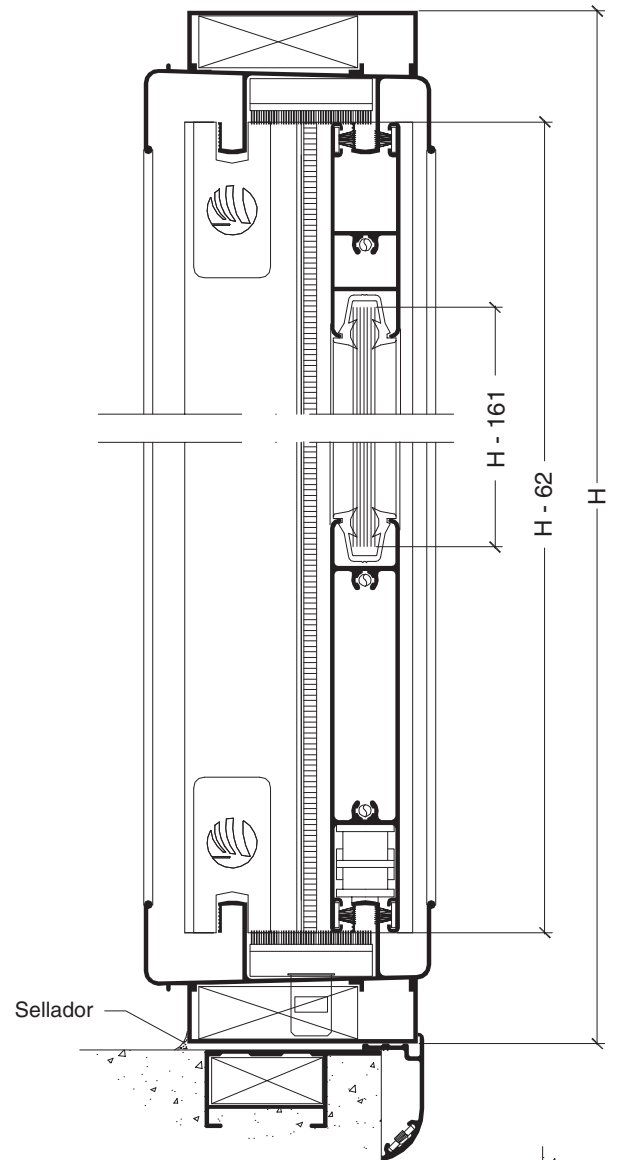

## Medidas de corte

# ROTONDA 640

Ventana corrediza 2 hojas corte a 90°  
Parante central distinto al lateral

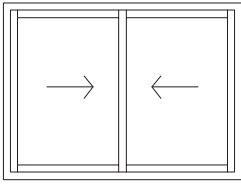

## Perfiles

Código	Descripción	Cant.	Medida	Corte
ADR 63	Marco	2	A	45°/45°
ADR 63	Marco	2	H	45°/45°
ADR 52A	Hoja	2	(A - 227)/2	90°/90°
ADR 53A	Parante lateral	4	H - 62	90°/90°
ADR 54	Parante central	2	H - 62	90°/90°

## Accesorios

Código	Descripción	Cant.
AA201	Escuadra de tracción	4
AA203	Cierre lateral	2
AA205	Tapón parante lateral	4
AA206	Tapón parante central	4
AA209	Cortavientos	2
AA210	Tope de hoja	2
AA211	Tapa parante corrediza	4
AA212	Tapón caja de agua	2
AA213	Tornillo de armado	12
AA214	Boca de desagüe de agua	2
AA503	Rueda	4
AG001S	Felpa 7 x 6 con fin seal	6H + 4A
AG003S	Burlete universal medio	4H + 2A

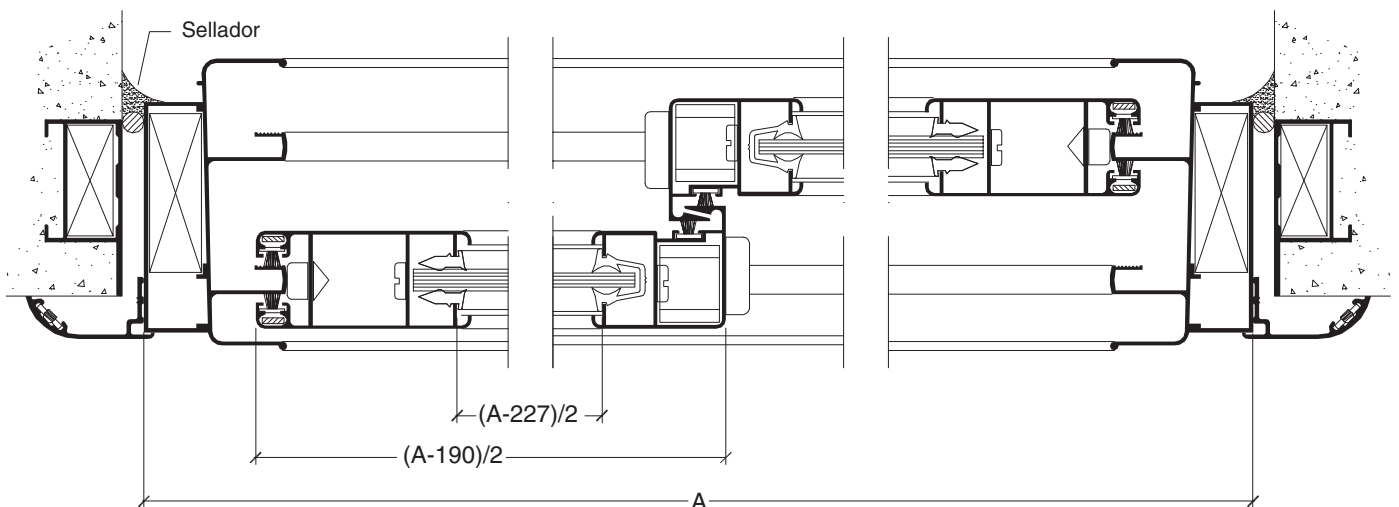
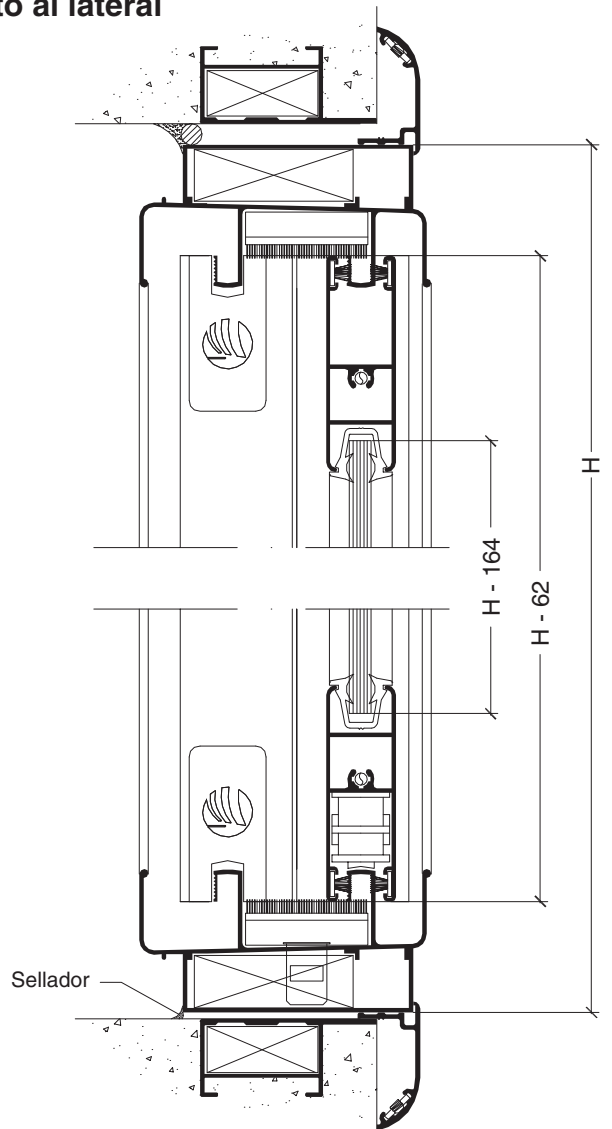

## Medidas de corte

# ROTONDA 640

## Ventana de abrir de 1 hoja

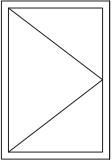

### Perfiles

Código	Descripción	Cant.	Medida	Corte
ADR 1160	Marco de 64 mm	2	A	45°/45°
ADR 1160	Marco de 64 mm	2	H	45°/45°
ADR 1162	Hoja batiente	2	A - 38	45°/45°
ADR 1162	Hoja batiente	2	H - 38	45°/45°
ADR 922	Pletina	*	*	90°/90°

\*en función del tipo de accesorio utilizado

### Accesorios

Código	Descripción	Cant.
AA014	Tapa desagüe	**
AA255	Escuadra para marcos de 64 mm	4
AA256	Escuadra para hojas de 29 mm	4
AA257	Bisagra de dos cuerpos	2
AA252-1	Falleba ventana	1
AA252-2	Kit para falleba	1
AG002E(1)	Burlete para vidrio de 3-4 mm	2A + 2H
AG060E	Burlete doble contacto exterior	2A + 2H
AG061E	Burlete doble contacto interior	2A + 2H

(1) Seleccionar el burlete de acuerdo al vidrio utilizado

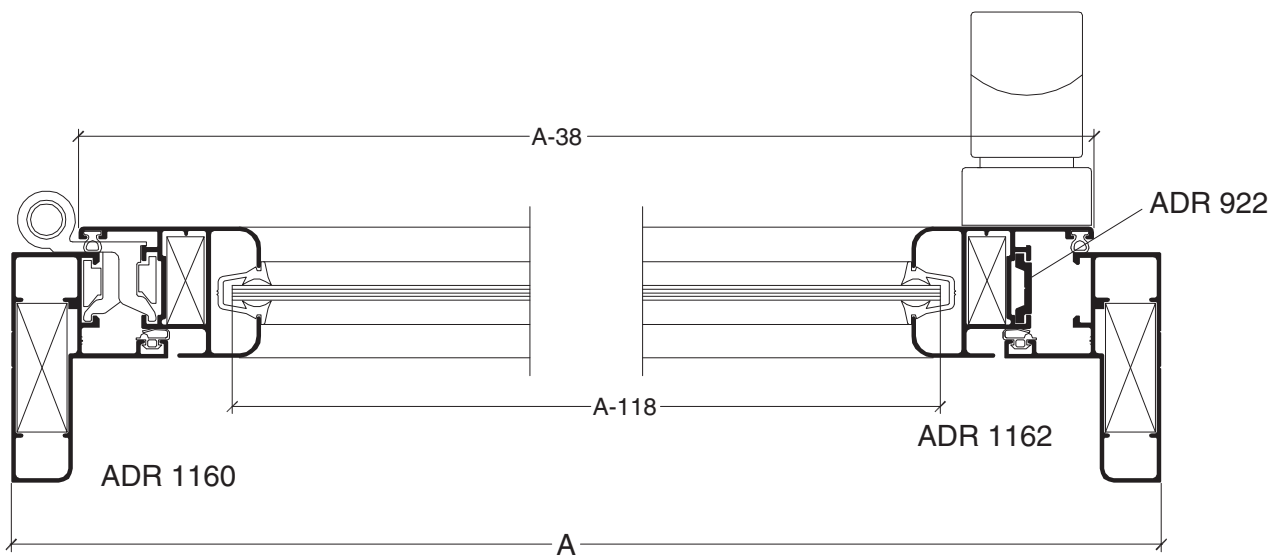
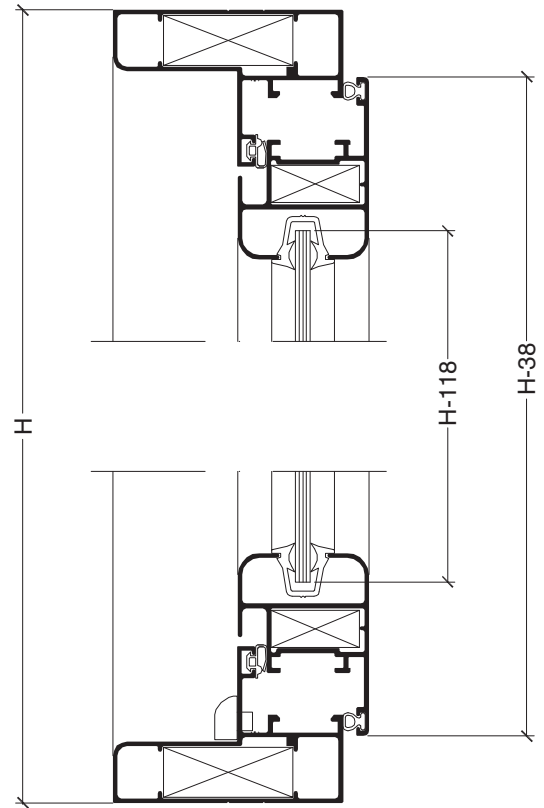

## Medidas de corte

# ROTONDA 640

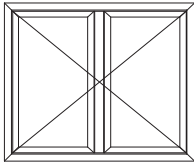

## Ventana de abrir de 2 hojas

### Perfiles

Código	Descripción	Cant.	Medida	Corte
ADR 1160	Marco de 64 mm	2	A	45°/45°
ADR 1160	Marco de 64 mm	2	H	45°/45°
ADR 1162	Hoja batiente	4	$(A - 42)/2$	45°/45°
ADR 1162	Hoja batiente	4	H - 38	45°/45°
ADR 1169	Postizo doble hoja	1	H - 92	90°/90°
ADR 922	Pletina	*	*	90°/90°

\*en función del tipo de accesorio utilizado

### Accesorios

Código	Descripción	Cant.
AA014	Tapa desagüe	**
AA107	Escuadra alineamiento	4
AA254	Encuentro central doble hoja	1 par
AA255	Escuadra para marcos de 64 mm	4
AA256	Escuadra para hojas de 29 mm	8
AA257	Bisagra de dos cuerpos	4
AA252-1	Falleba ventana	1
AA252-2	Kit para falleba	1
AA263	Pasador 2º hoja ventana	1
AA275	Traba varillas y 3º cierre	2
AG002E(1)	Burlete para vidrio de 3-4 mm	2A + 4H
AG060E	Burlete doble contacto exterior	2A + 3H
AG061E	Burlete doble contacto interior	2A + 4H

(1) Seleccionar el burlete de acuerdo al vidrio utilizado

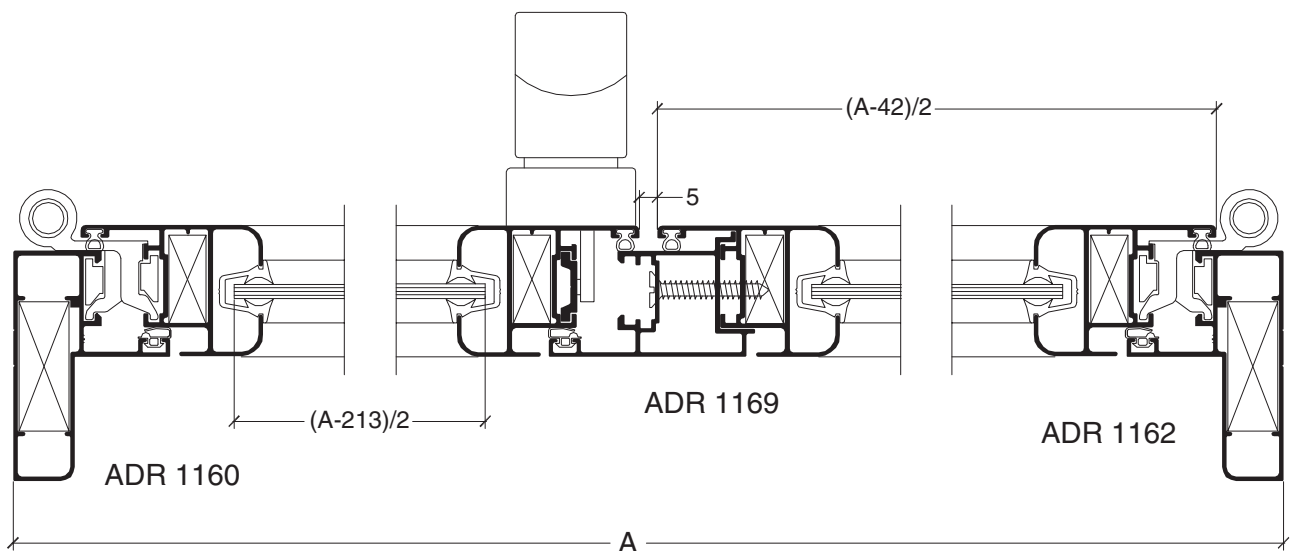
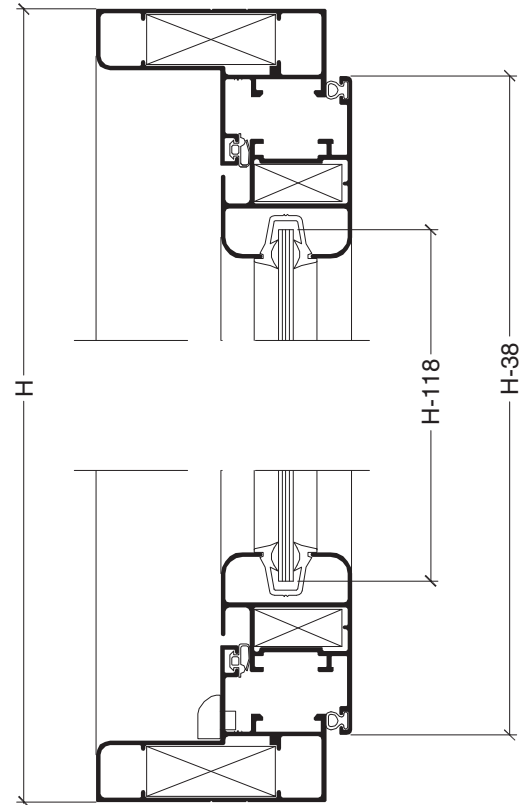

## Medidas de corte

# ROTONDA 640

## Ventana banderola

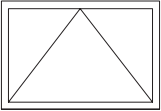

### Perfiles

Código	Descripción	Cant.	Medida	Corte
ADR 1160	Marco de 64 mm	2	A	45°/45°
ADR 1160	Marco de 64 mm	2	H	45°/45°
ADR 1162	Hoja batiente	2	A - 39	45°/45°
ADR 1162	Hoja batiente	2	H - 39	45°/45°

### Accesorios

Código	Descripción	Cant.
AA014	Tapa desagüe	**
AA255	Escuadra para marcos de 64 mm	4
AA256	Escuadra para hojas de 29 mm	4
AA257	Bisagra de dos cuerpos	2
AA261	Limitador de apertura banderola	1 par
AA274	Cierre banderola encámara	1
AG002E(1)	Burlete para vidrio de 3-4 mm	2A + 2H
AG060E	Burlete doble contacto exterior	2A + 2H
AG061E	Burlete doble contacto interior	2A + 2H

(1) Seleccionar el burlete de acuerdo al vidrio utilizado

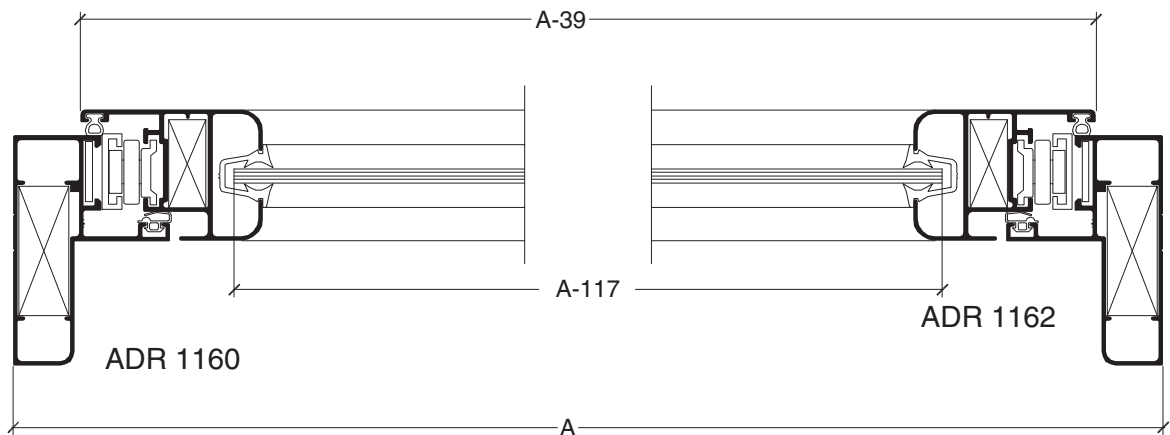
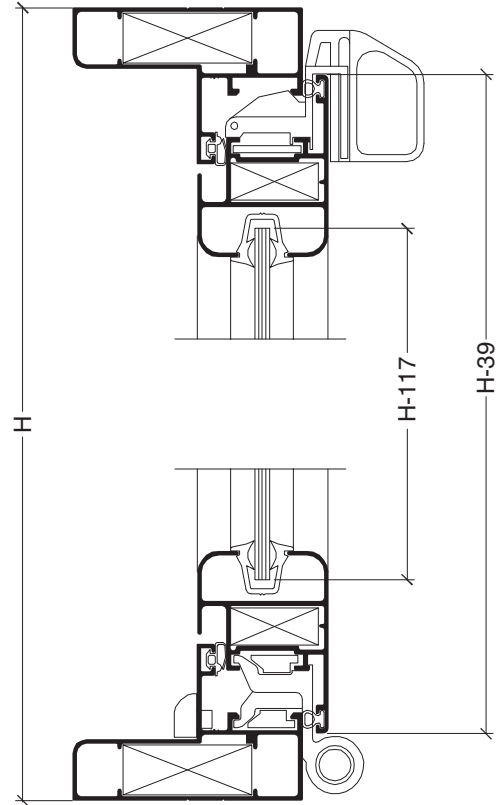

## Medidas de corte

# ROTONDA 640

## Ventana desplazable

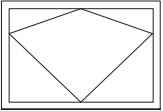

### Perfiles

Código	Descripción	Cant.	Medida	Corte
ADR 1171	Marco proyectante de 64 mm	2	A	45°/45°
ADR 1171	Marco proyectante de 64 mm	2	H	45°/45°
ADR 1173	Hoja proyectante	2	A - 29	45°/45°
ADR 1173	Hoja proyectante	2	H - 29	45°/45°

### Accesorios

Código	Descripción	Cant.
AA107	Escuadra alineamiento	4
AA035	Aldaba ventana proyectante	1
AA255	Escuadra para marcos de 64 mm	4
AA256	Escuadra para hojas de 29 mm	4
AA125/126	Tijera para proyectante	1 par
AG002E(1)	Burlete para vidrio de 3-4 mm	2A + 2H
AG060E	Burlete doble contacto exterior	2A + 2H
AG061E	Burlete doble contacto interior	2A + 2H

(1) Seleccionar el burlete de acuerdo al vidrio utilizado

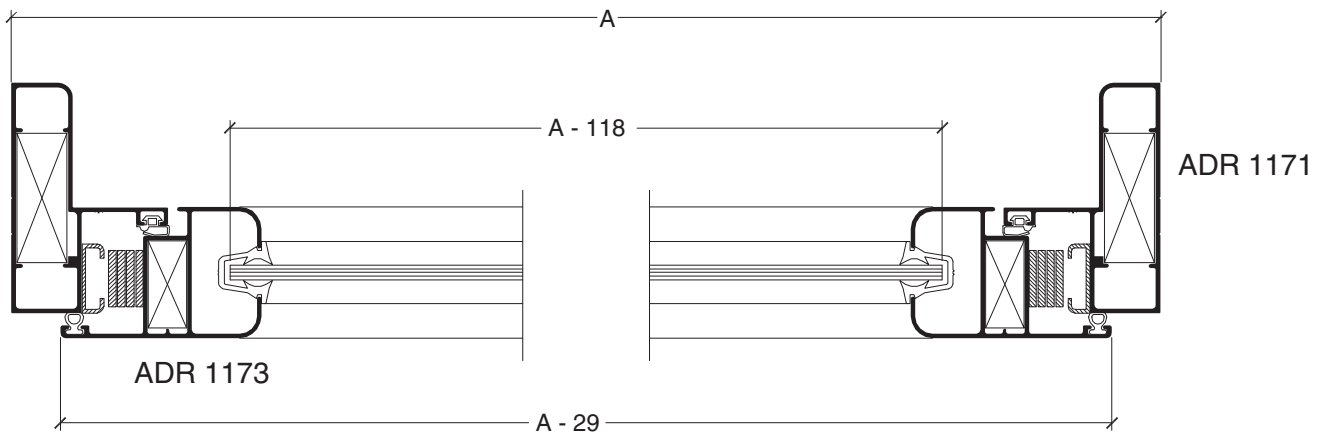
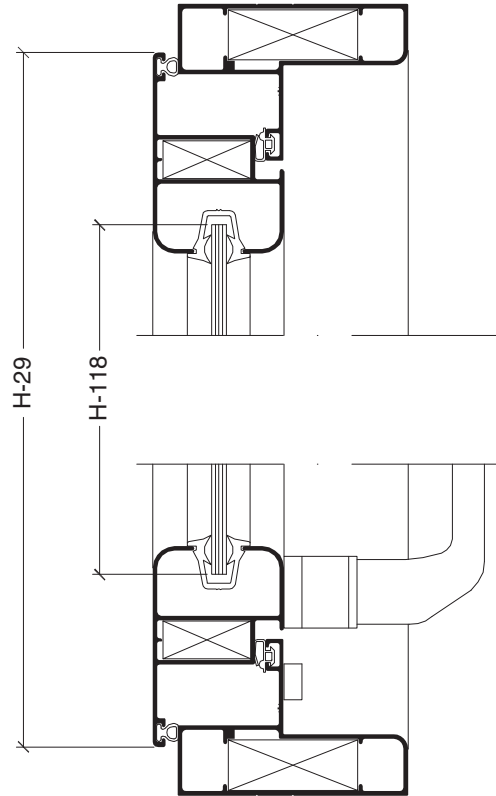

## Medidas de corte

# ROTONDA 640

## Puerta de una hoja

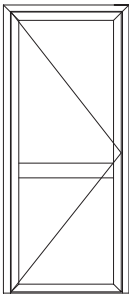

### Perfiles

Código	Descripción	Cant.	Medida	Corte
ADR 1512	Marco de 64 mm	1	A	45°/45°
ADR 1512	Marco de 64 mm	2	H	45°/90°
ADR 1166	Hoja puerta para vidrio simple	2	A - 47	45°/45°
ADR 1166	Hoja puerta para vidrio simple	2	H - 23 - D	45°/45°
ADR 1167	Travesaño para vidrio simple	1	A - 197	90°/90°
ADR 1170	Porta felpas puerta	1	A - 102	90°/90°
ADR 255	Bota Agua	1	A - 102	90°/90°

### Accesorios

Código	Descripción	Cant.
AA107	Escuadra de alineamiento	16
AA255	Escuadra para marcos de 64 mm	2
AA256	Escuadra para hojas de 29 mm	4
AA259	Bisagra de tres cuerpos	2
AA268	Manija doble balancín	1
AA273	Cerradura para puerta	1
AG002E(1)	Burlete para vidrio de 3-4 mm	2A + 2H
AG060E	Burlete doble contacto exterior	A + 2H
AG061E	Burlete doble contacto interior	A + 2H
AG064S	Felpa 7 x 6 con fin seal	A

(1) Seleccionar el burlete de acuerdo al vidrio utilizado

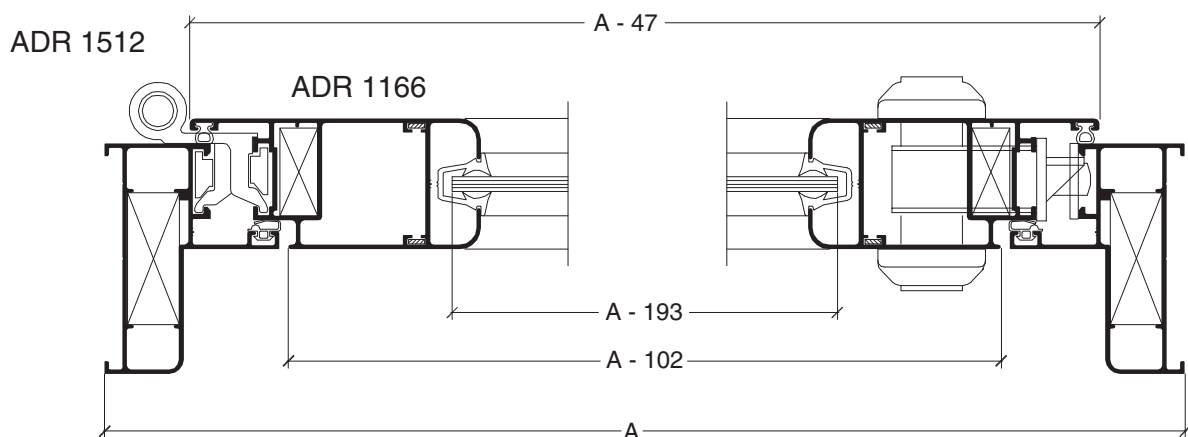
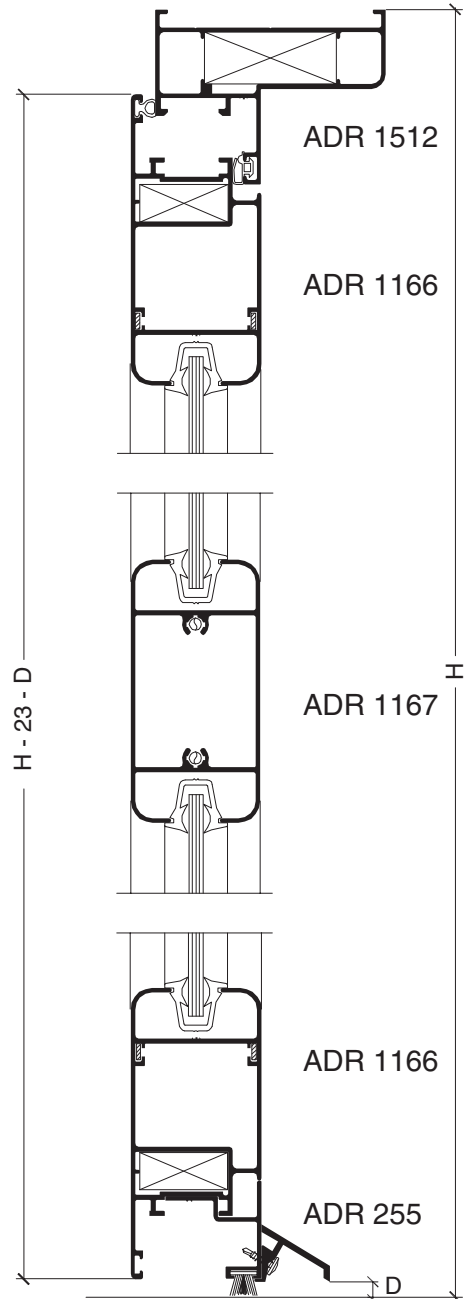

## Medidas de corte

# ROTONDA 640

## Puerta de dos hojas

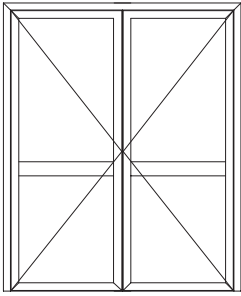

### Perfiles

Código	Descripción	Cant.	Medida	Corte
ADR 1160	Marco de 64 mm	1	A	45°/45°
ADR 1160	Marco de 64 mm	2	H	45°/90°
ADR 1166	Hoja puerta para vidrio simple	4	$(A - 42)/2$	45°/45°
ADR 1166	Hoja puerta para vidrio simple	4	H - 19 - D	45°/45°
ADR 1167	Travesaño para vidrio simple	2	$(A - 171)/2$	90°/90°
ADR 1169	Postizo doble hoja	1	H - 79 - D	90°/90°
ADR 1170	Portafelpas puerta	2	$(A - 152)/2$	90°/90°

### Accesorios

Código	Descripción	Cant.
AA107	Escuadra de alineamiento	16
AA255	Escuadra para marcos de 64 mm	2
AA256	Escuadra para hojas de 29 mm	8
AA259	Bisagra de tres cuerpos	4
AA268	Manija doble balancín	1
AA273	Cerradura para puerta	1
AG002E(1)	Burlete para vidrio de 3-4 mm	4A + 4H
AG060E	Burlete doble contacto exterior	A + 3H
AG061E	Burlete doble contacto interior	A + 4H
AG064S	Felpa 7 x 6 con fin seal	A

(1) Seleccionar el burlete de acuerdo al vidrio utilizado

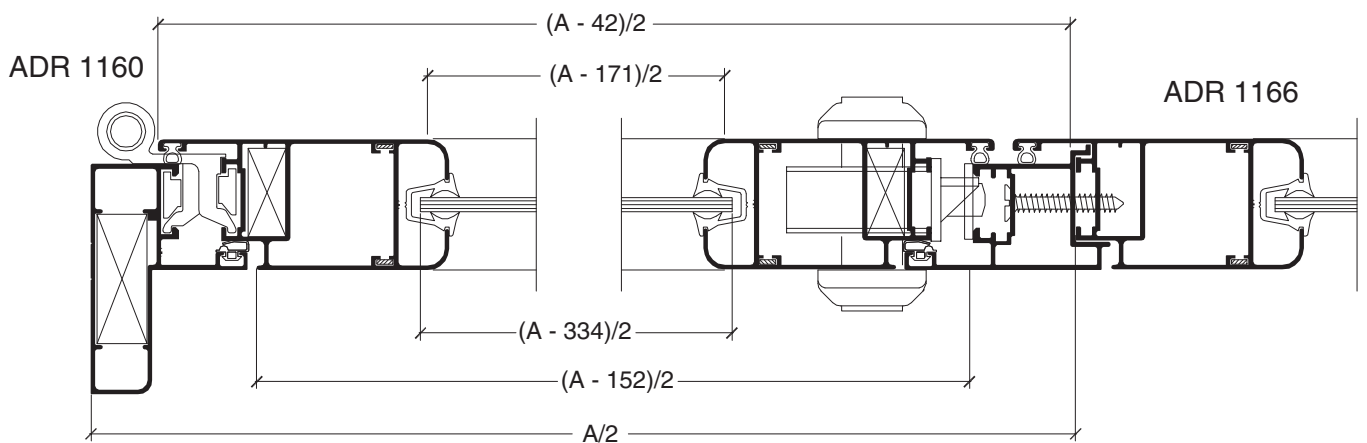
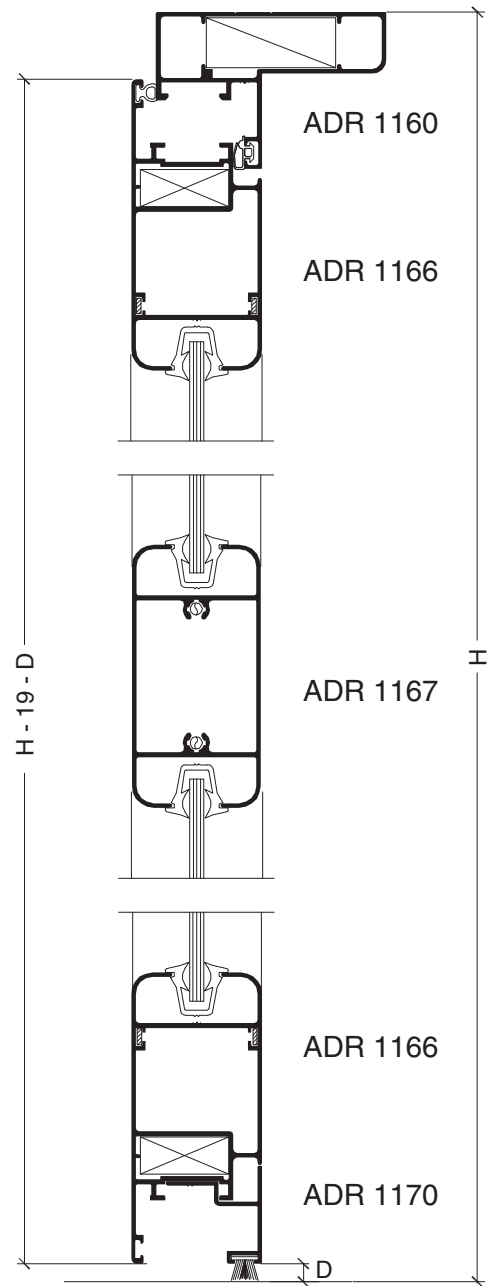

## Medidas de corte

# ROTONDA 640

Corrediza corte a 45° - Colocación de escuadra AA201

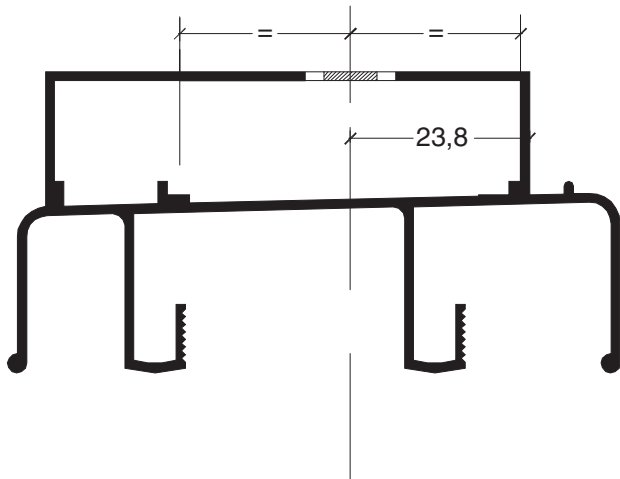

ADR 63 / ADR 374

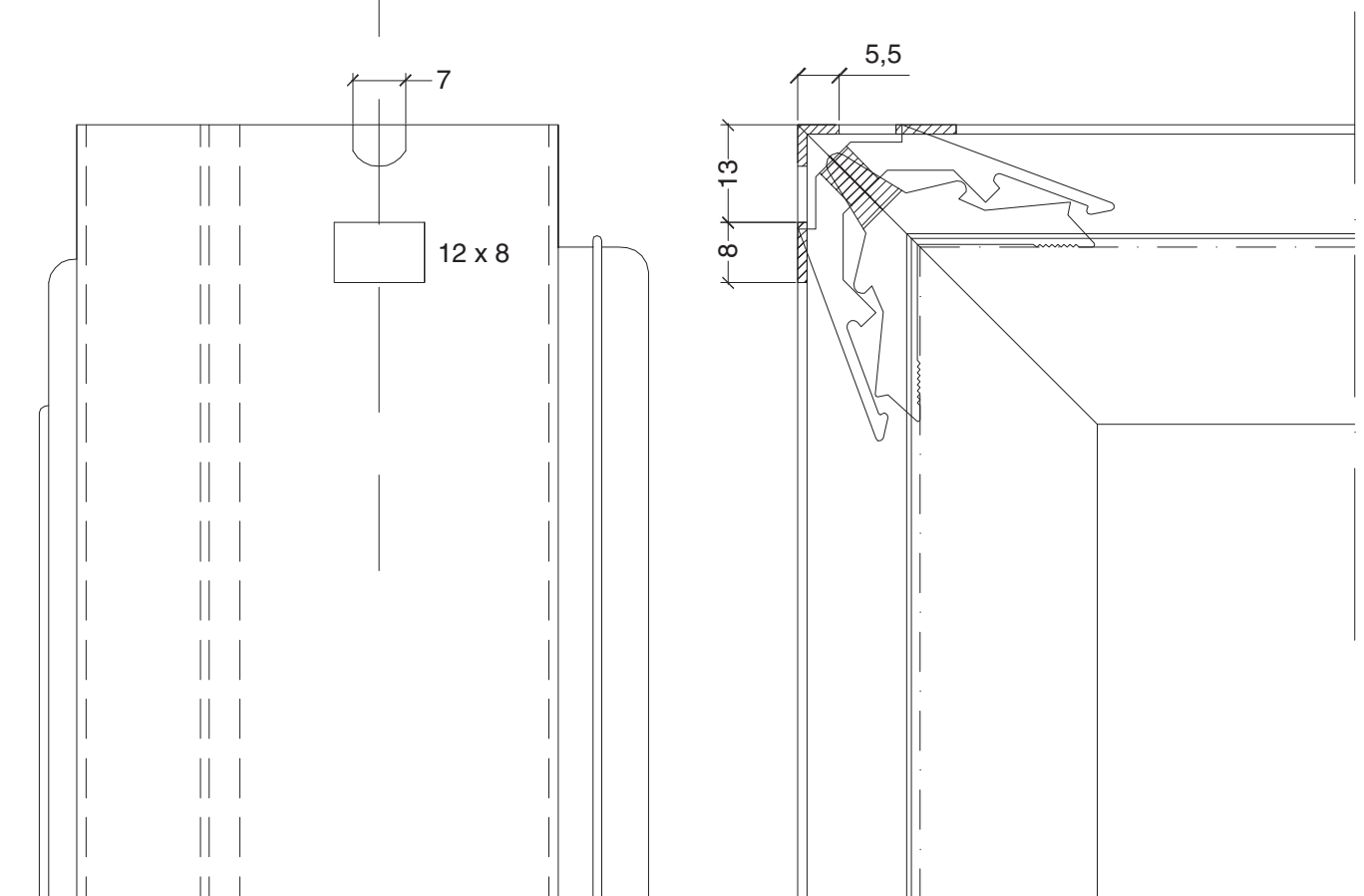

Mecanizados (Escala 1:1)

# ROTONDA 640

Corrediza corte a 45° - Colocación de escuadra AA255

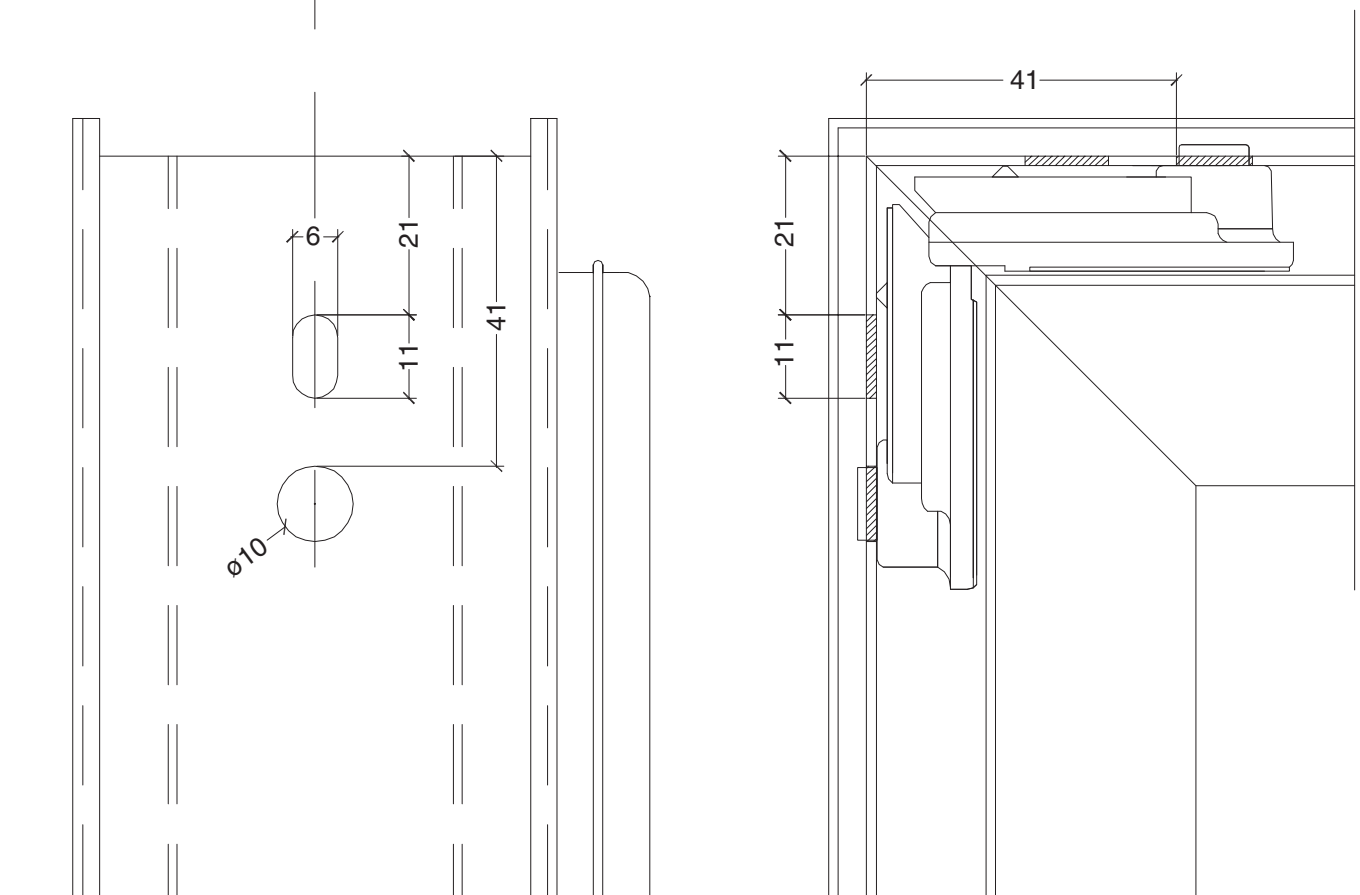
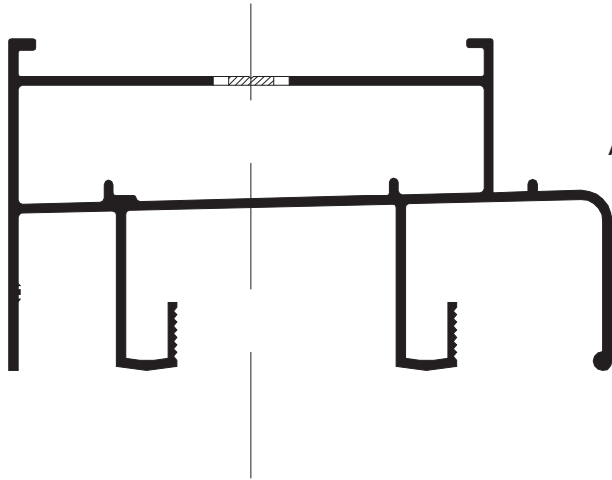

Mecanizados (Escala 1:1)

# ROTONDA 640

## Mecanizado de cierre lateral

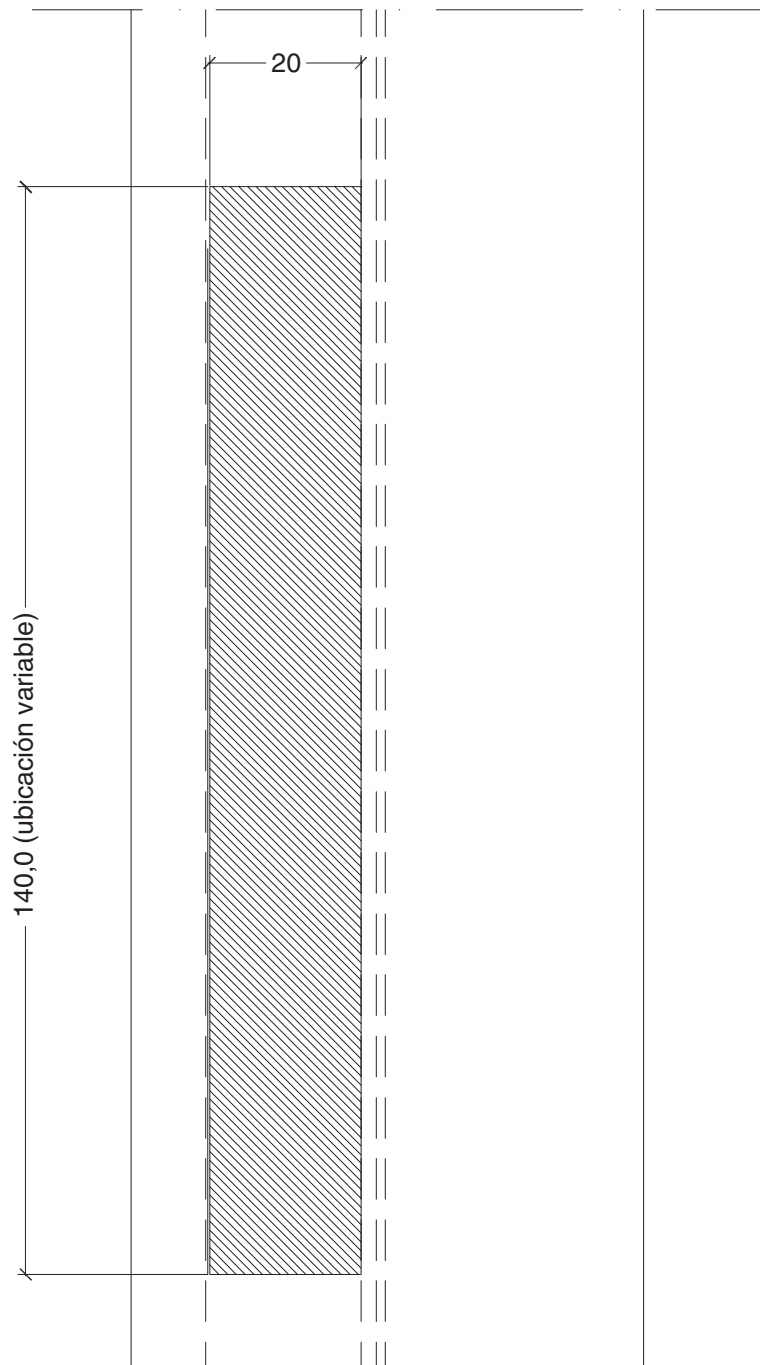

ADR 261 / ADR 366  
ADR 425 / ADR 1514  
ADR 1650

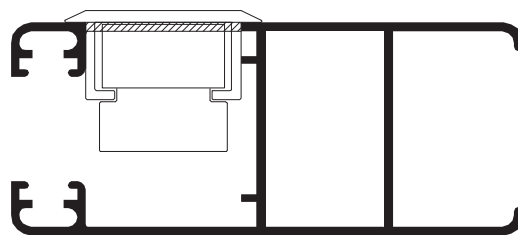

**Mecanizados (Escala 1:1)**

# ROTONDA 640

Calado pasaje de guías

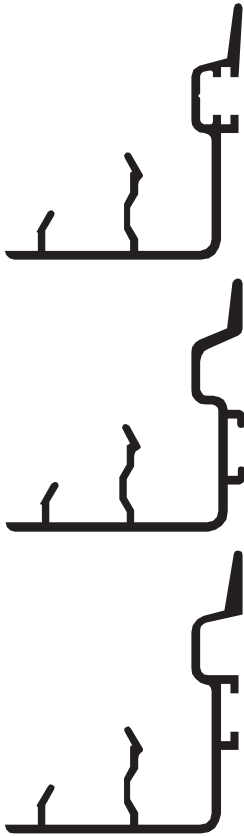

ADR 1516

ADR 172

ADR 262

Eliminación de aletas

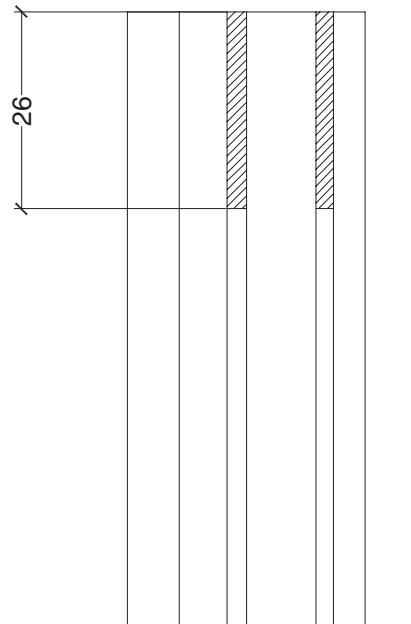
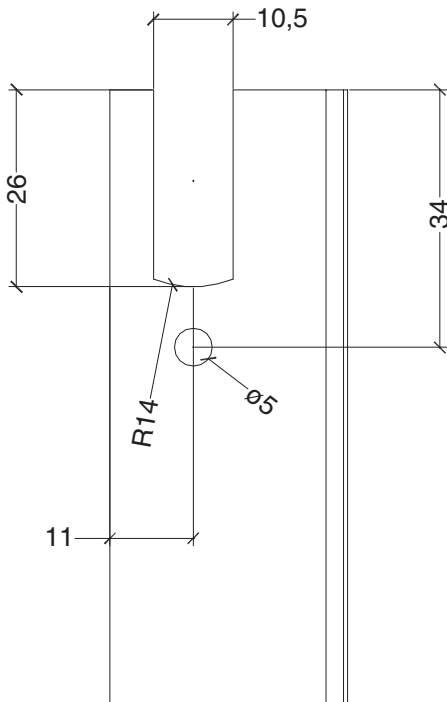
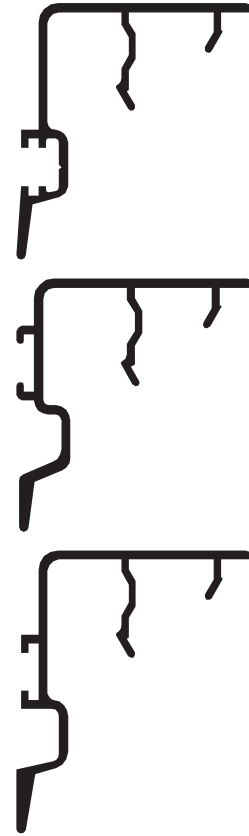

Mecanizados (Escala 1:1)

# ROTONDA 640

## Mecanizados de la caja de agua

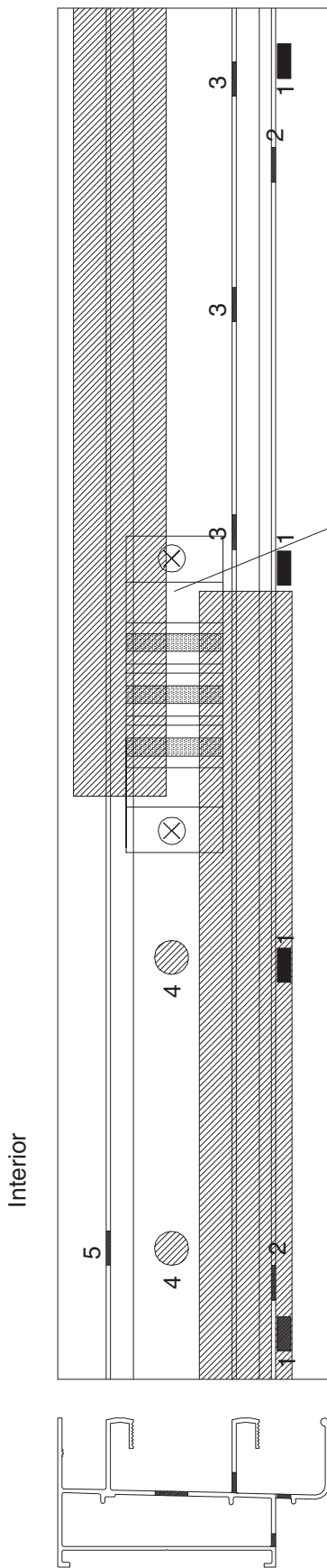

Cortavientos AA 209

5.- Desagote de condensación

4.- Desagote a la caja de agua

3.- Pasaje de agua a través de las guías

1.- Descarga del colector exterior

2.- Descarga de la caja de agua

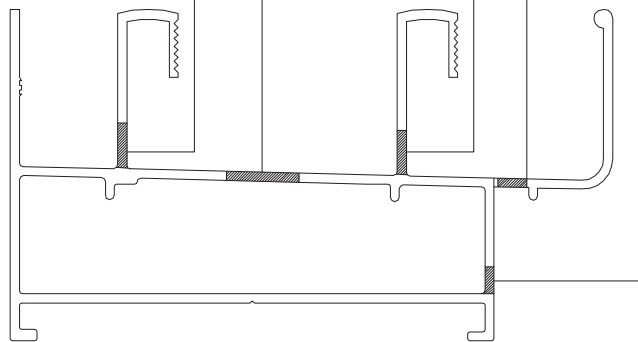

Mecanizados (Escala 1:1)

# ROTONDA 640

## Corrediza corte a 45° - Accesorios

Escuadra de  
alineación AA208

Guía de hoja AA202

AA202

AA256

AA 1514 / ADR 1650

AA208

36,5

14,5

11

10,5



Mecanizados (Escala 1:1)

# ROTONDA 640

Mecanizado para escuadra AA255 / AA003 con botón  $\varnothing 10$  mm.

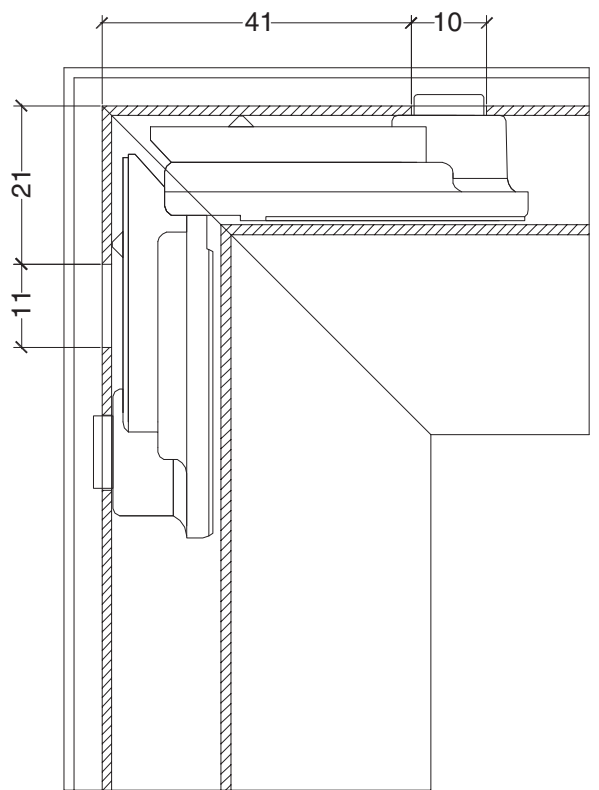
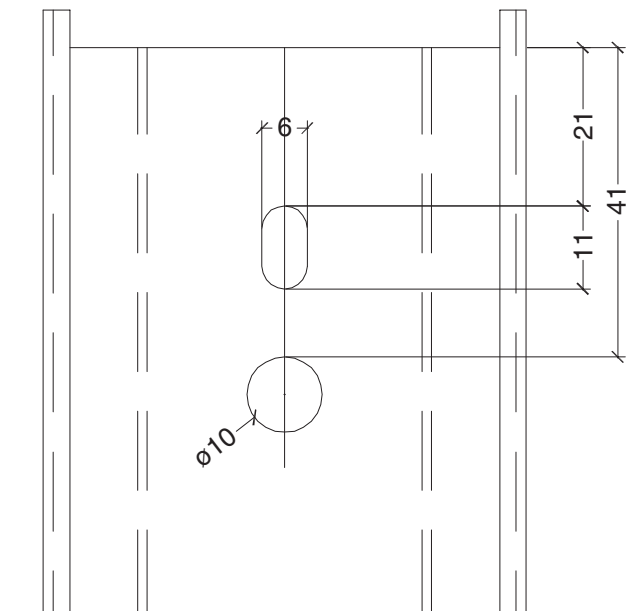
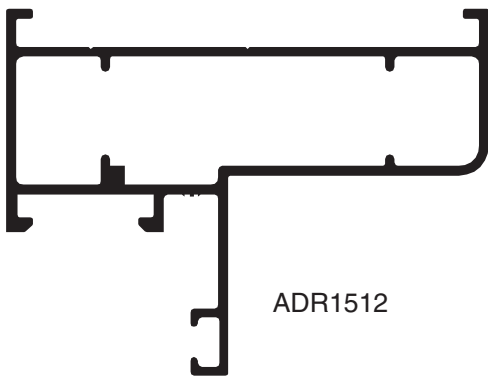
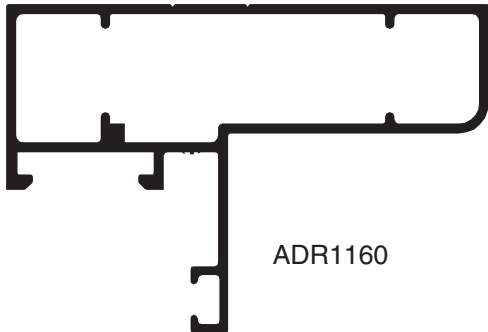

Mecanizados (Escala 1:1)

# ROTONDA 640

Mecanizado para escuadra AA256

ADR1172

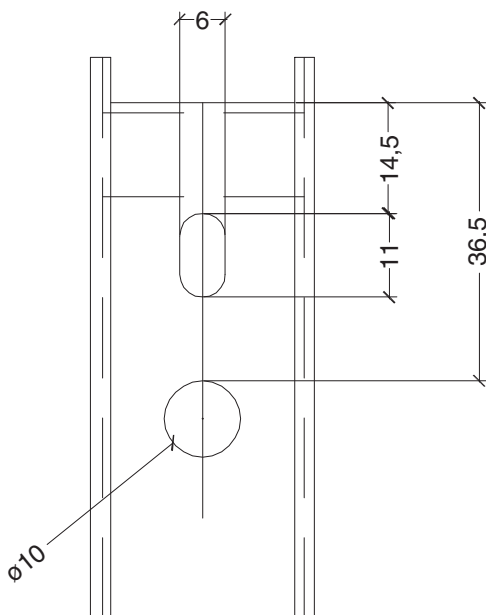
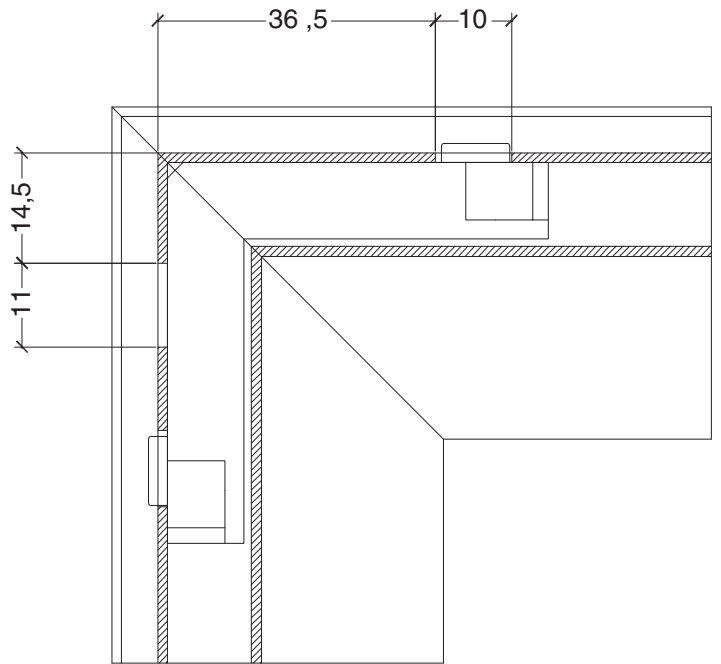
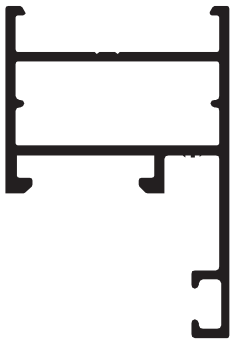

Mecanizados (Escala 1:1)

# ROTONDA 640

Cremona

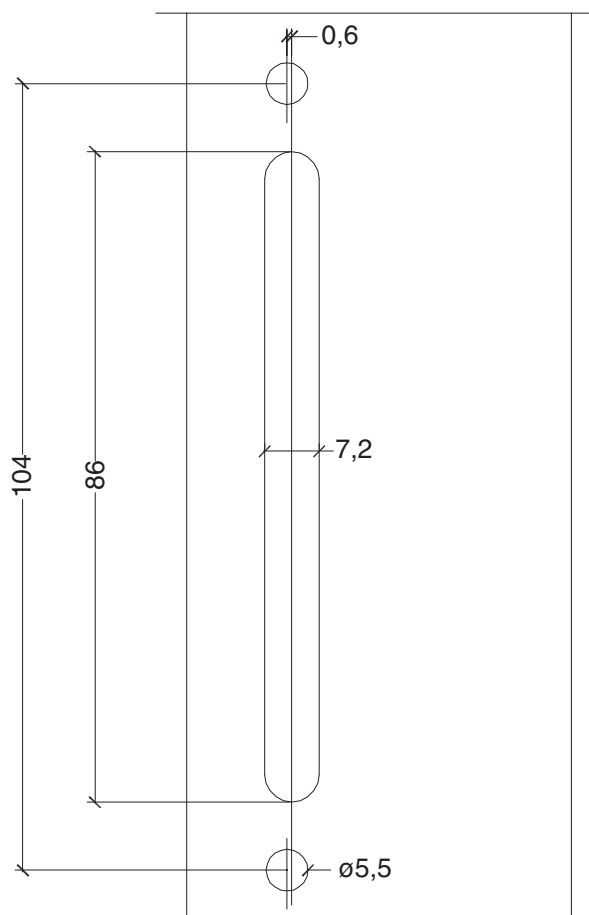
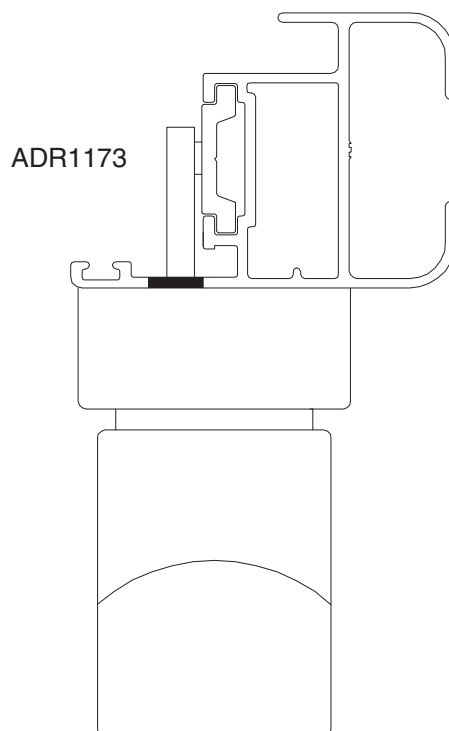

Mecanizados (Escala 1:1)

# ROTONDA 640

## Descarga de agua en marcos

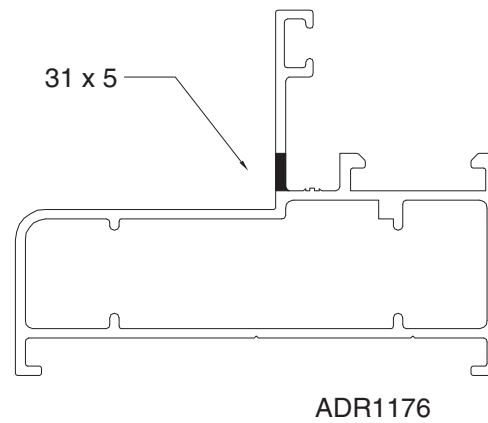
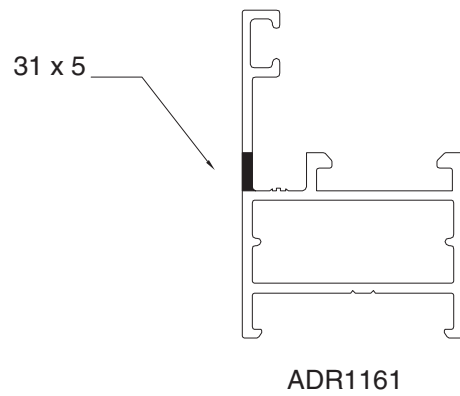
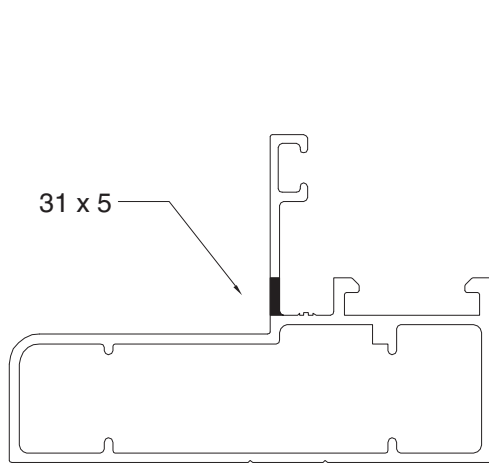

## Pletina

ADR 922 Pletina

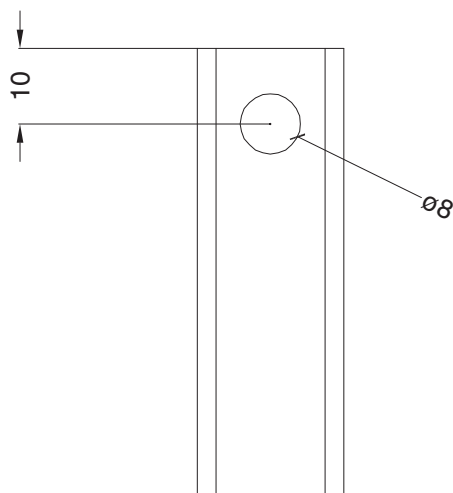

Mecanizados (Escala 1:1)

# ROTONDA 640

## Ubicación del tapón caja de agua - corte a 45°

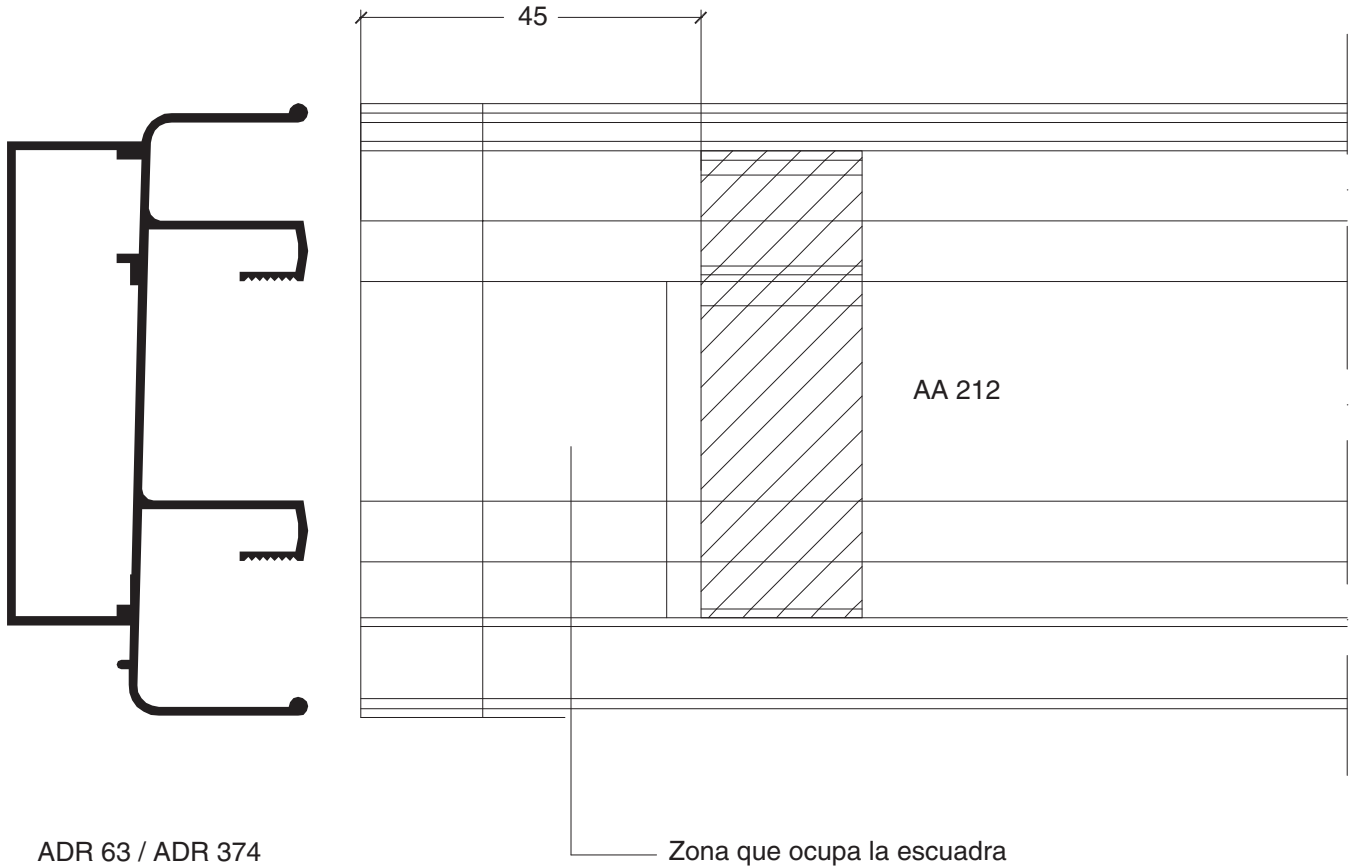

**Nota:** para los marcos ADR 1510 / ADR 1511 utilizar el tapón caja de agua AA 226

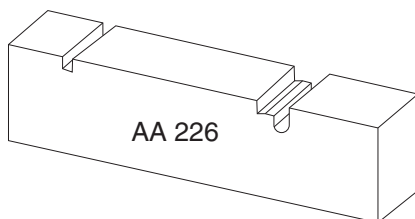

## Detalles (Escala 1:1)

# ROTONDA 640

## Colocación guía de cortina

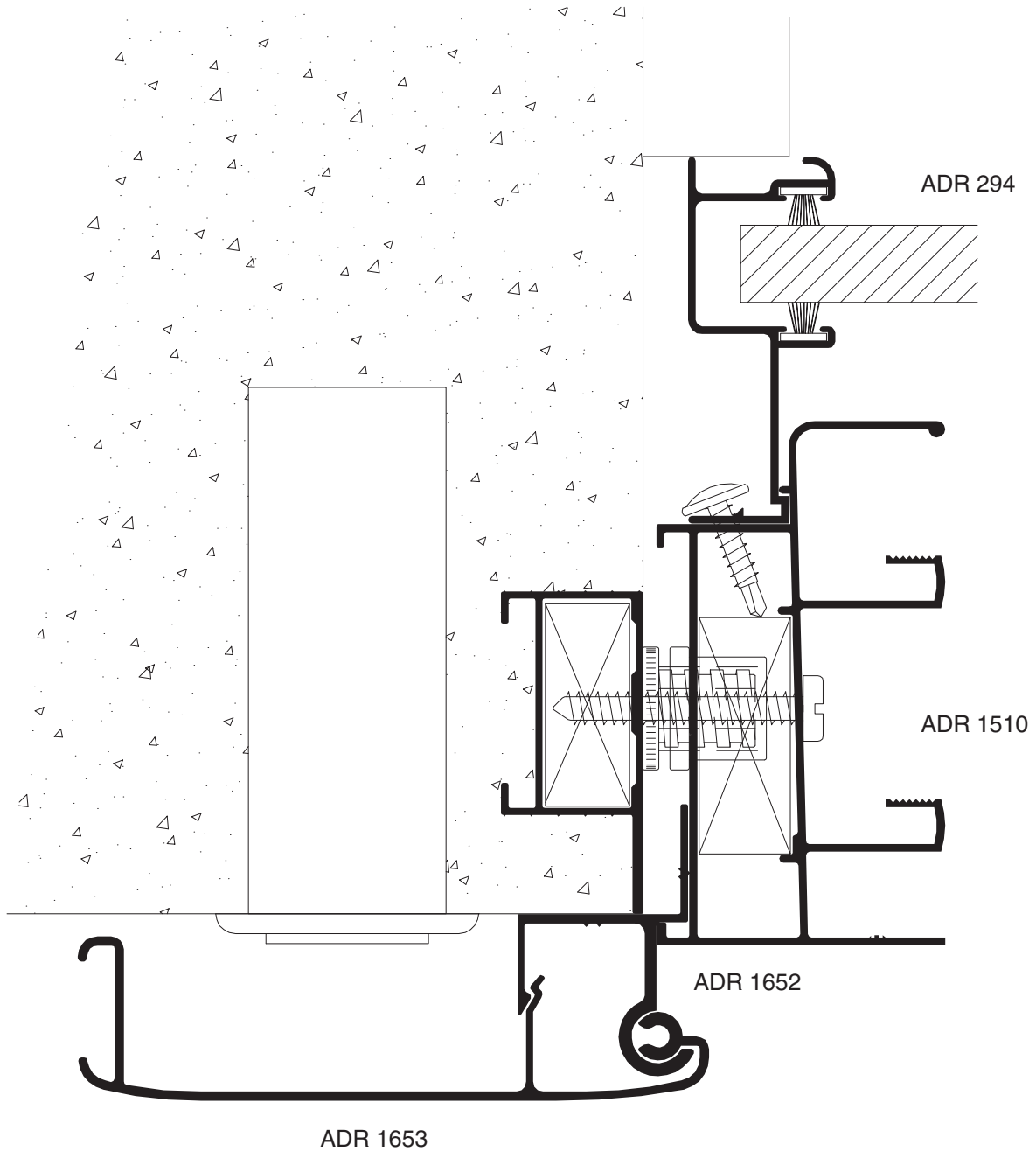

**Detalles (Escala 1:1)**

# ROTONDA 640

Luz libre de contravidrios

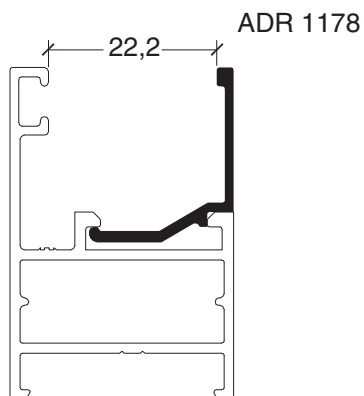
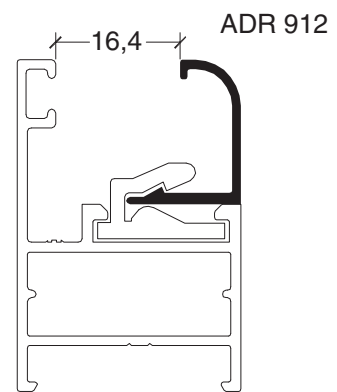
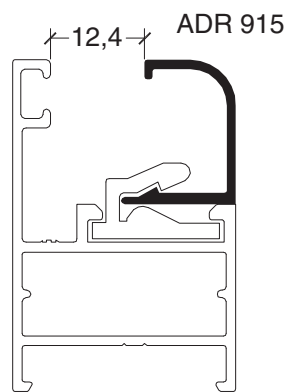
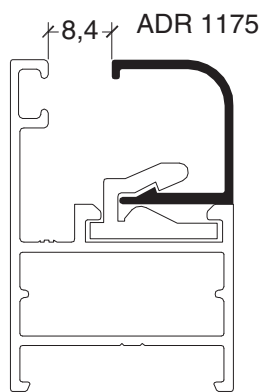
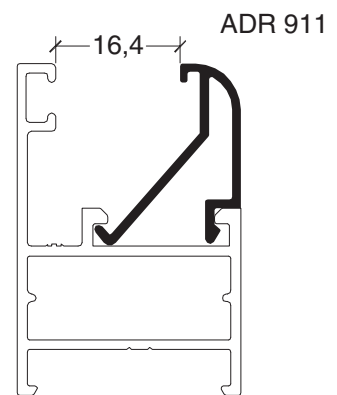
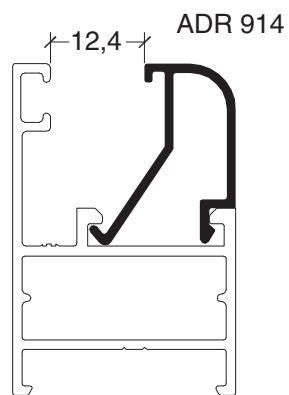
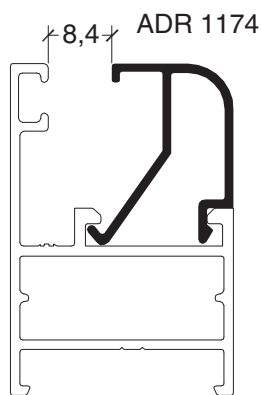
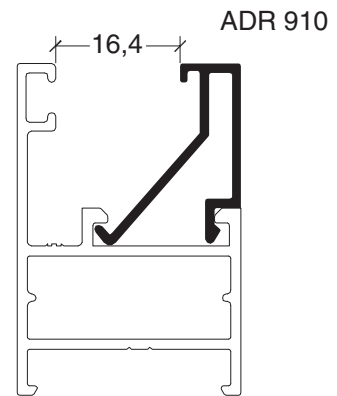
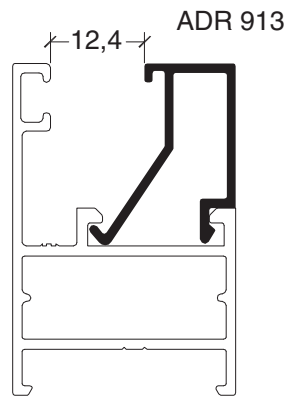
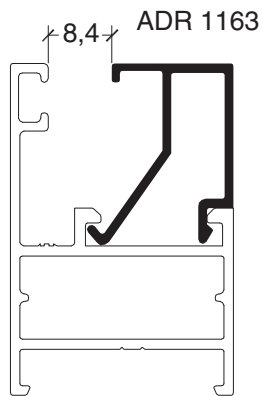

Detalles (Escala 1:1)

# ROTONDA 640

## Correcto taqueado de vidrios

Paño fijo

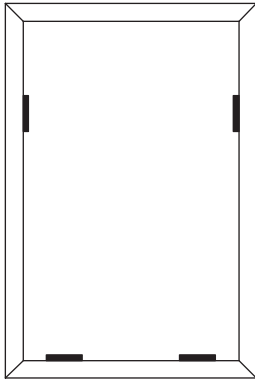

Ventana de abrir

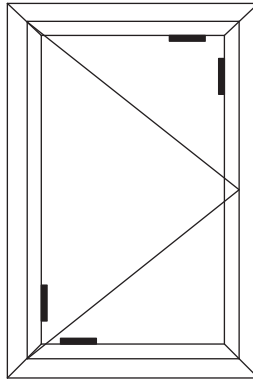

Ventana oscilo-batiente

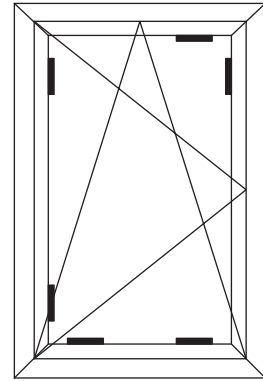

Puerta de abrir

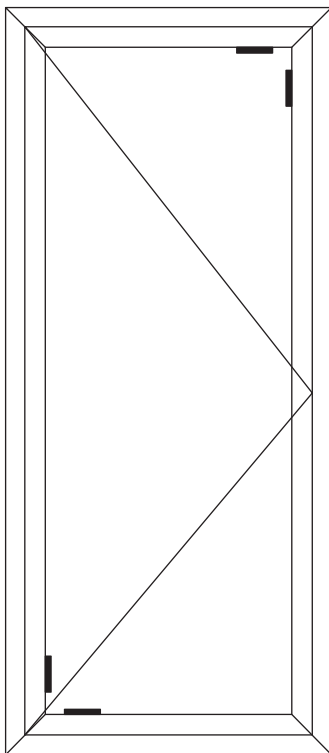

Ventana desplazable

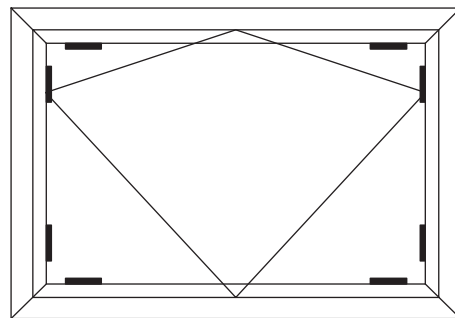

# ROTONDA 640

Armado de premarco con escuadra AA250

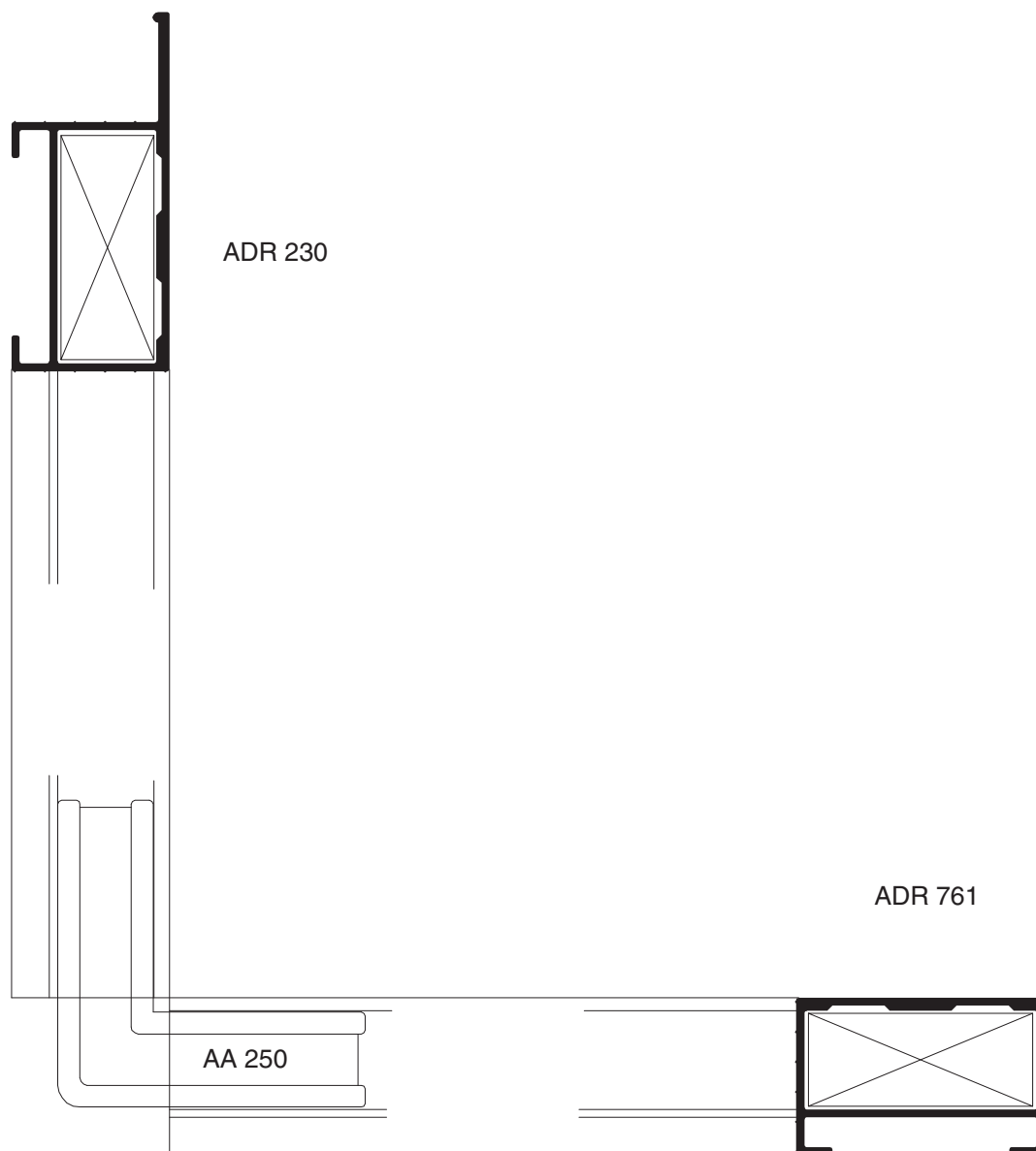

Detalles (Escala 1:1)

# ROTONDA 640

## Ubicación correcta del premarco

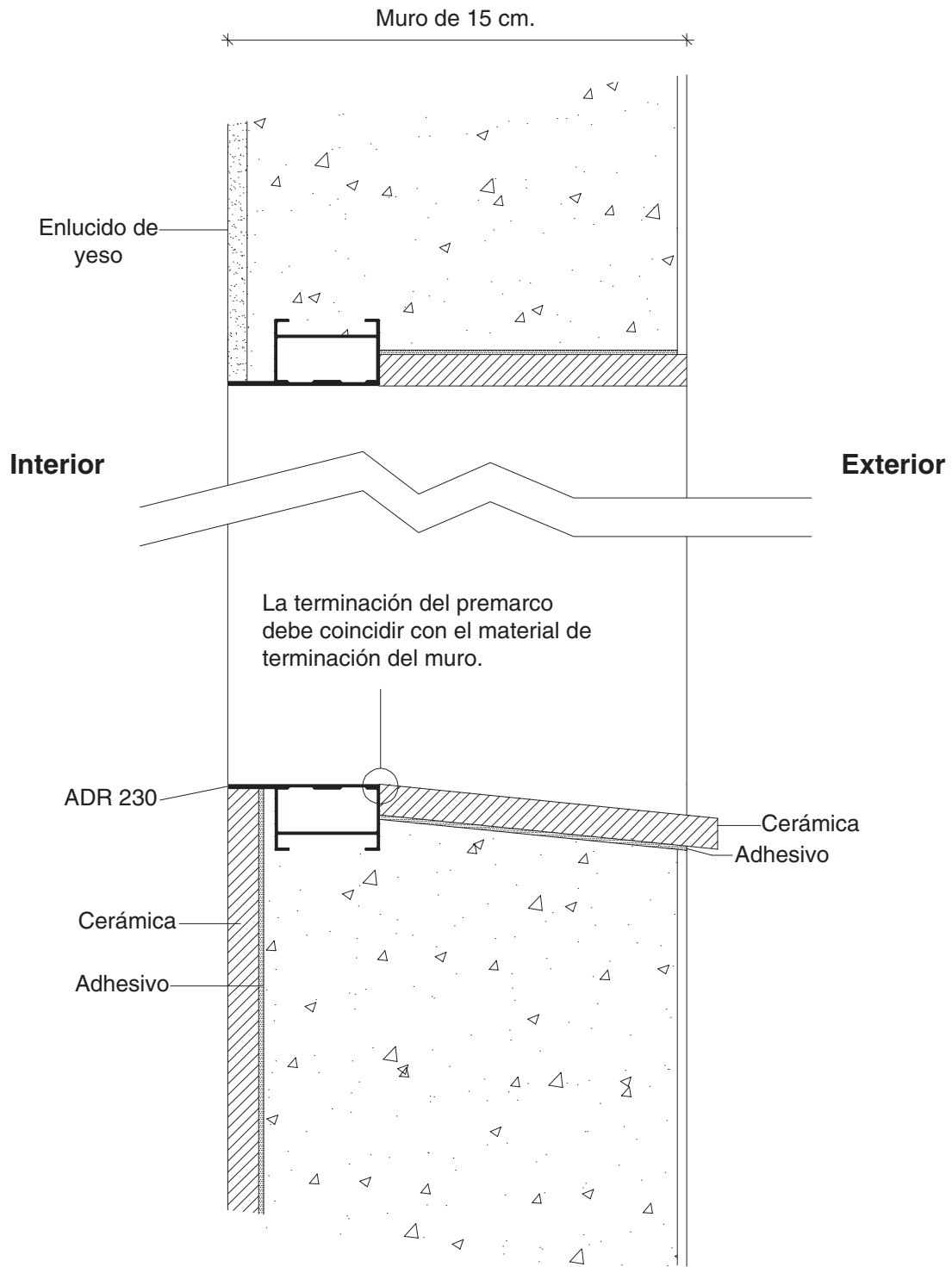

# ROTONDA 640

## Amplitud angular de la rótula

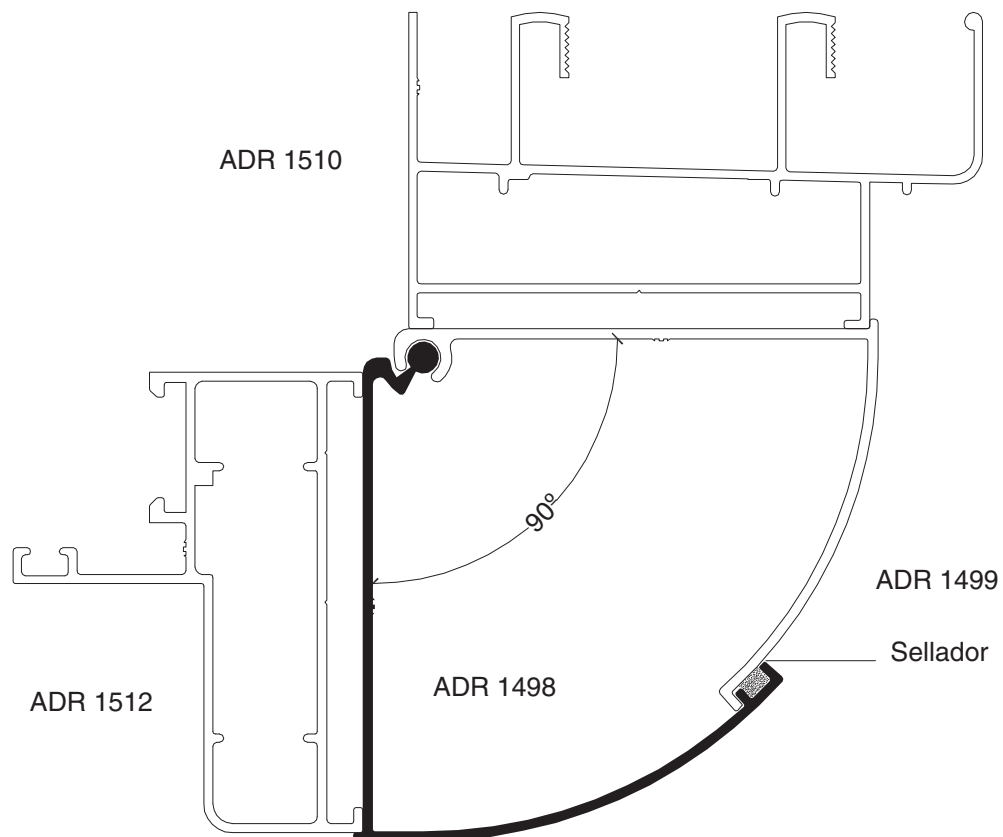
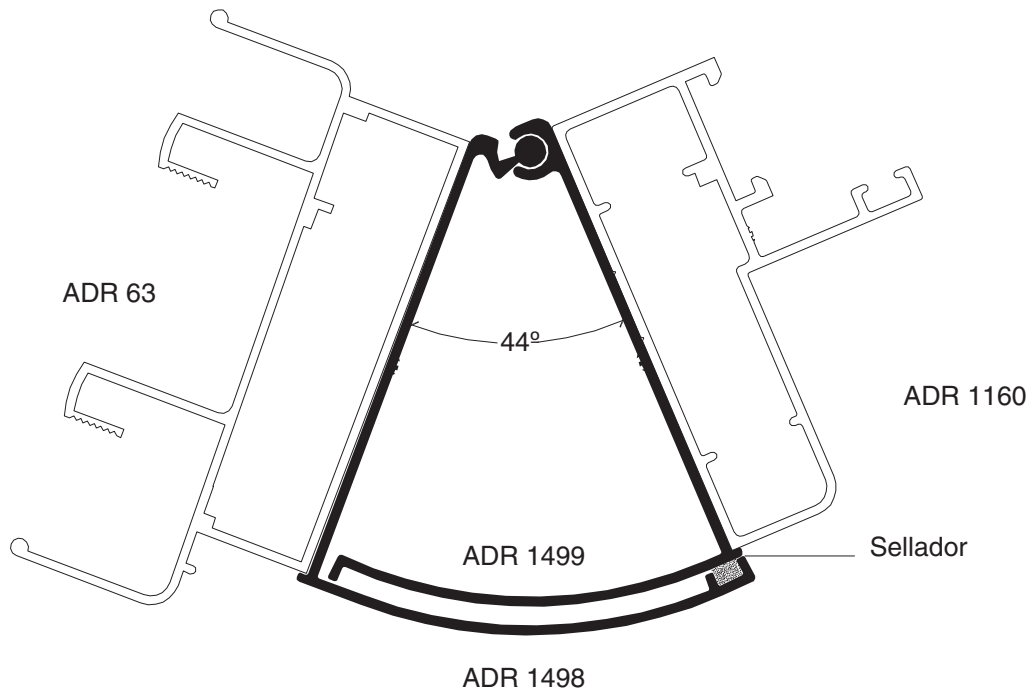

## Detalles

# ROTONDA 640

**El Departamento de Asistencia al Cliente está a disposición de profesionales, carpinteros y usuarios. Las consultas pueden realizarse por e-mail a:**

**asistencia@hydro.com.ar  
comercial@hydro.com.ar**

**www.hydro.com.ar**

**Impreso en Buenos Aires, julio de 2011.**



**Asistencia Técnica**